

1:200

Řez A-A'

A1

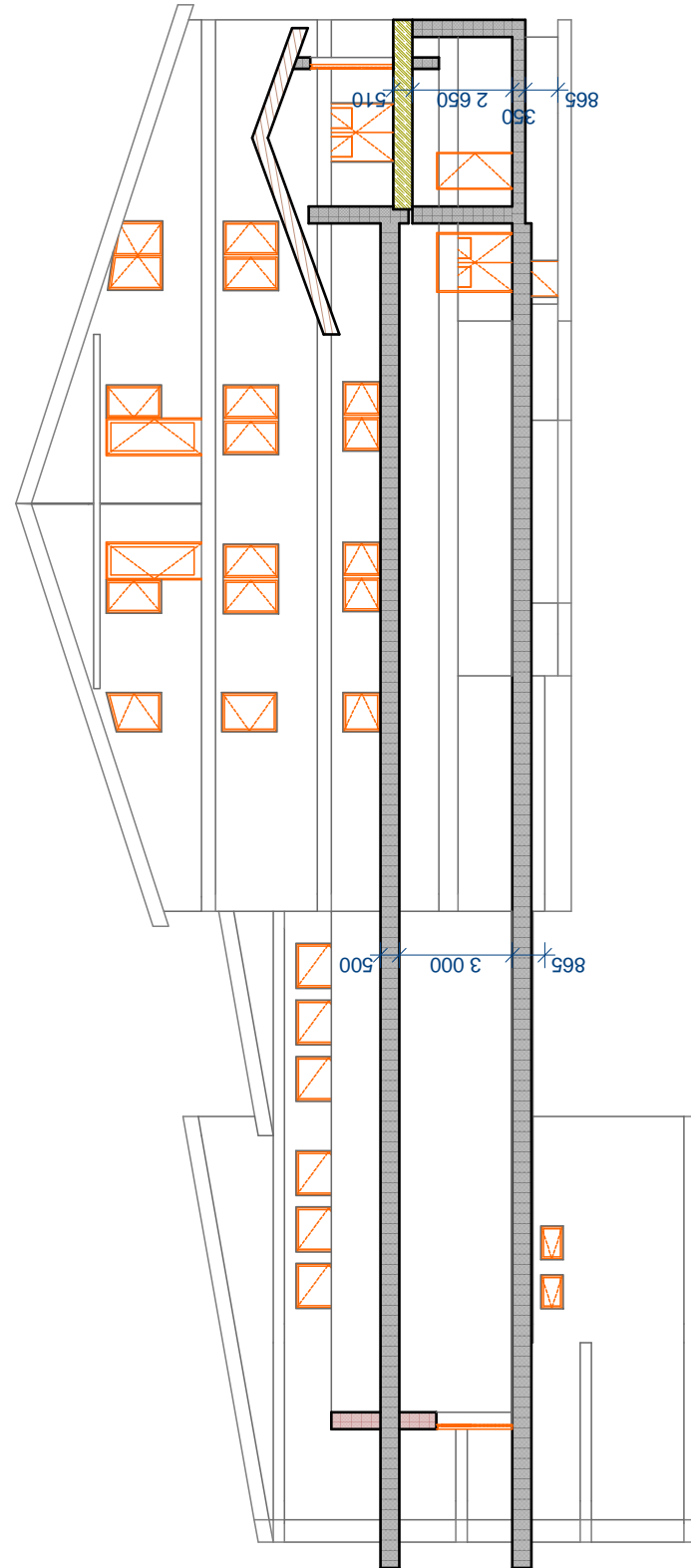

1:200

Řez A-A'

A2

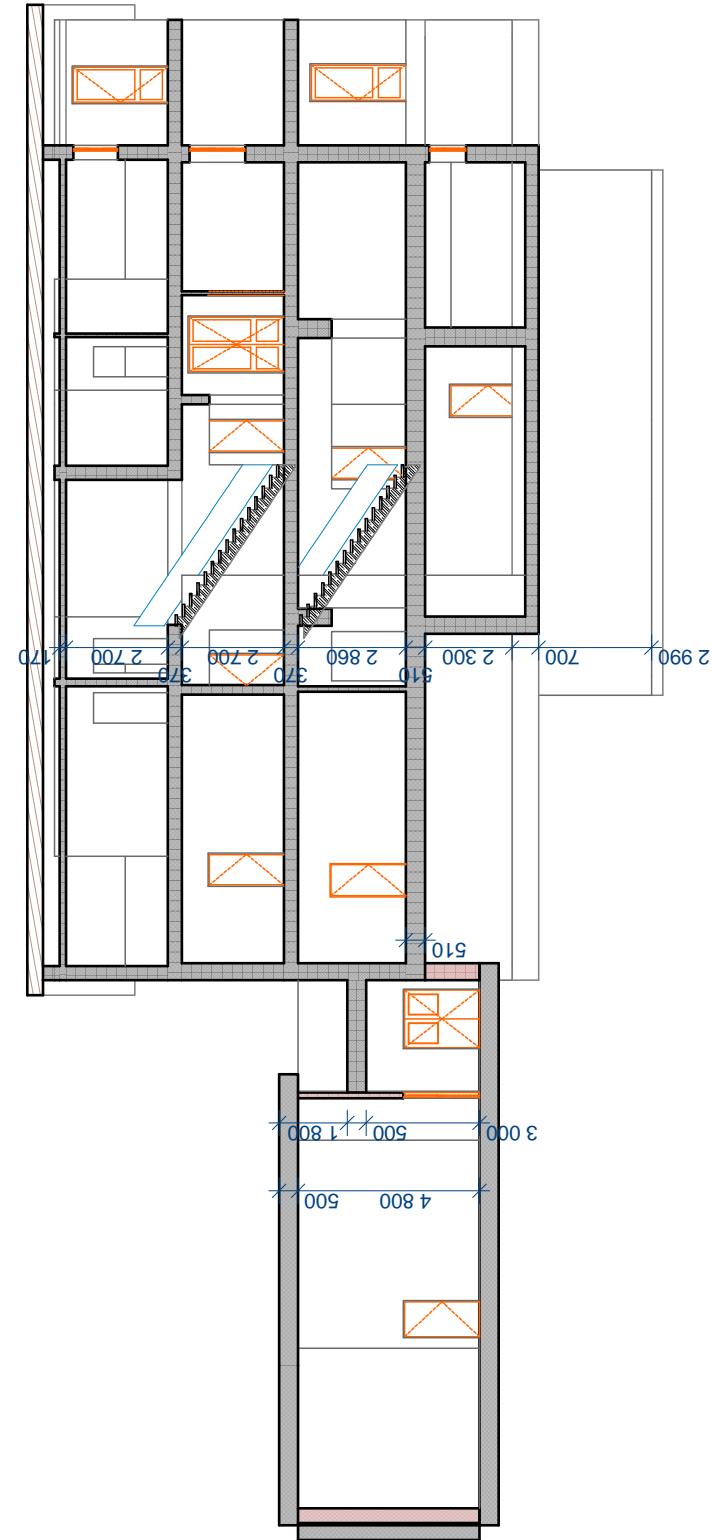

1:200

Řez A-A'

A3

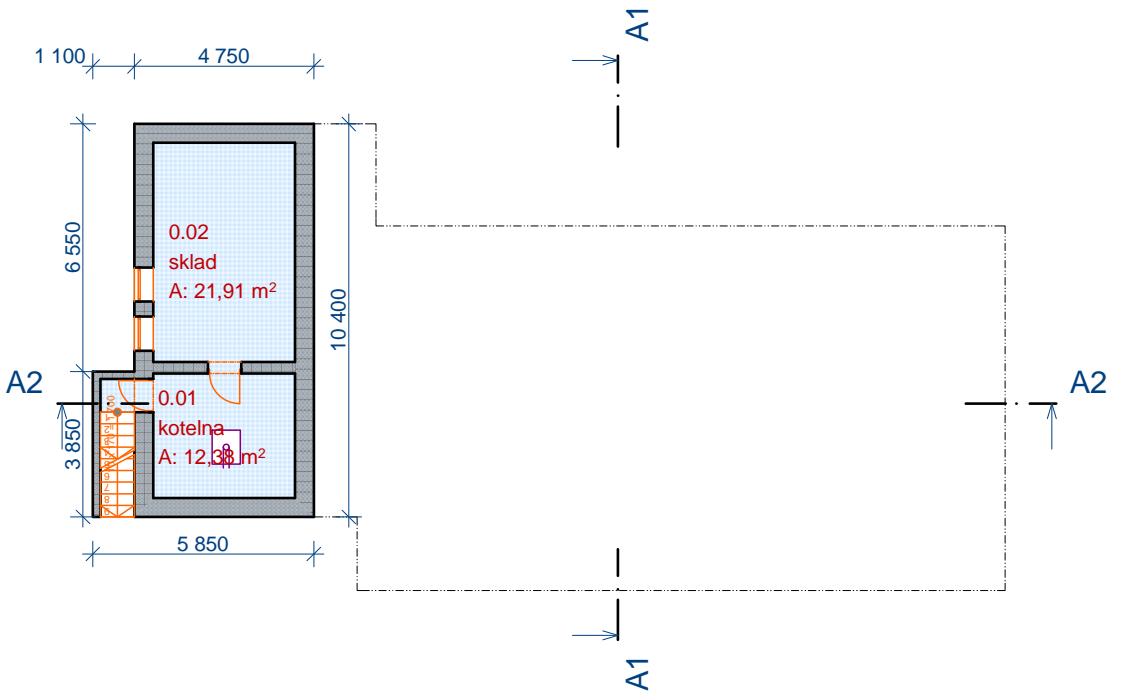
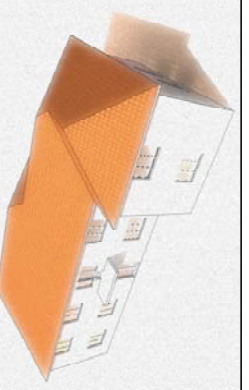

-1. 1.PP 1:200

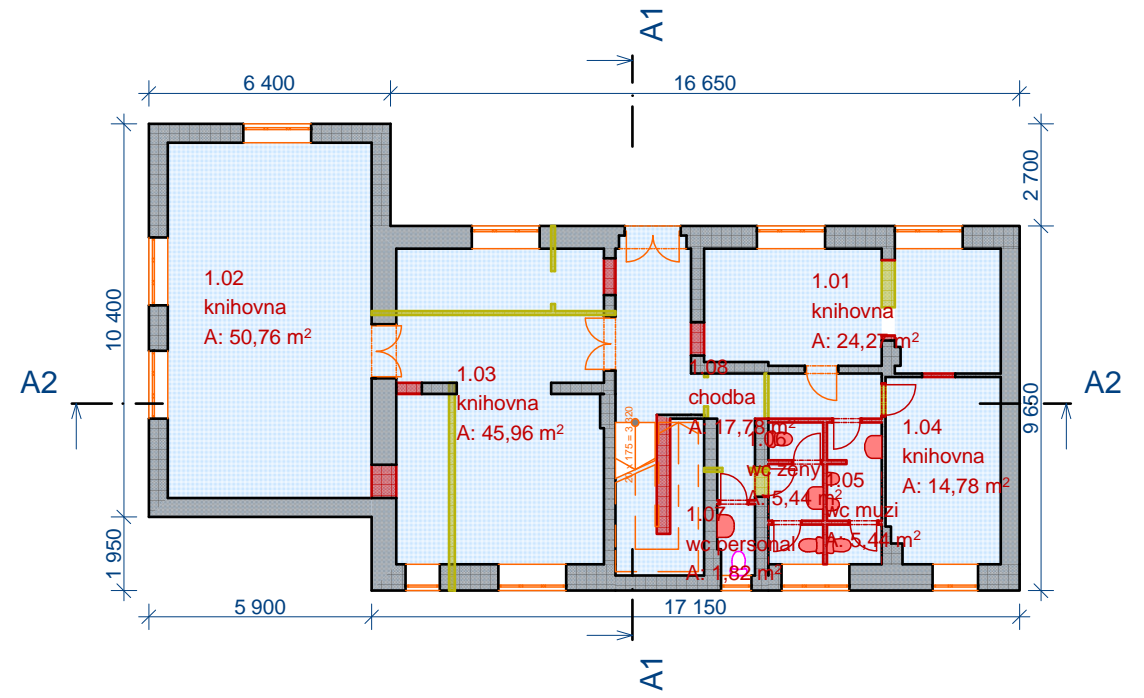

1. 1.NP 1:200

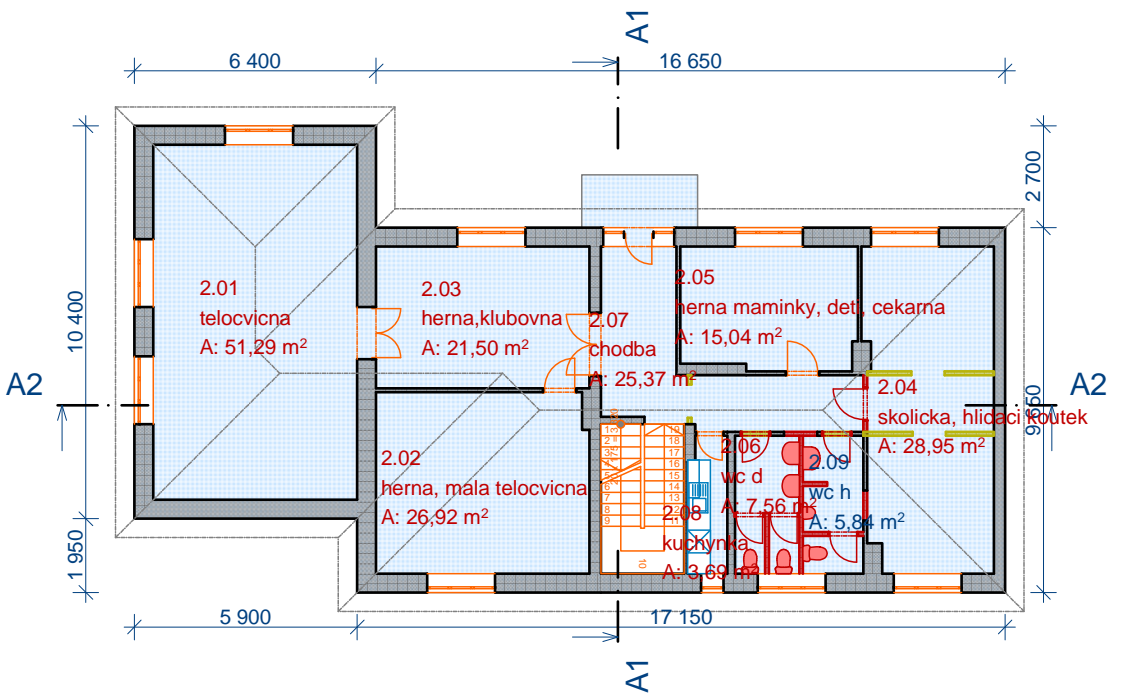

2. 2.NP 1:200

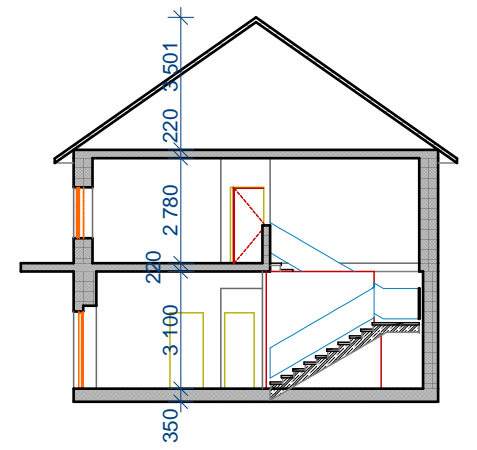

A1 Řez A-A' 1:200 A2

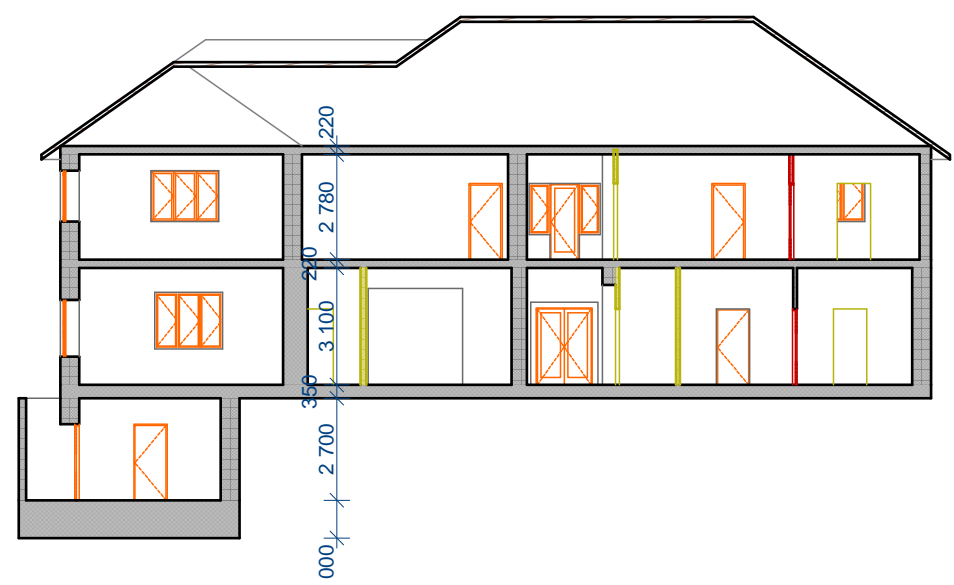

Řez A-A' 1:200

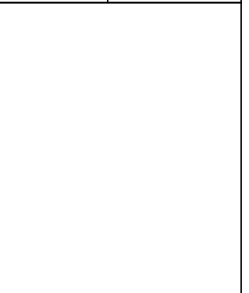

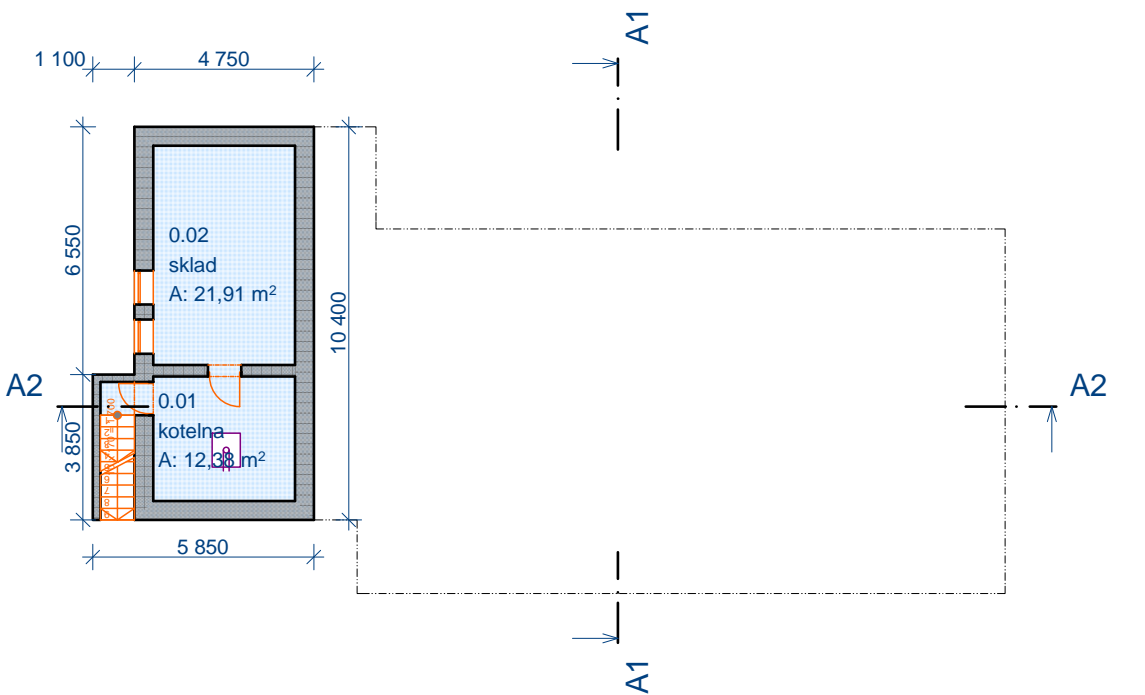
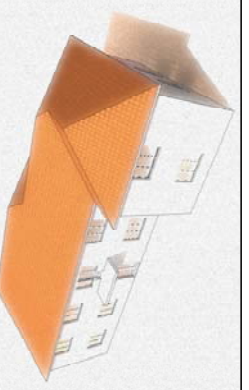

-1. 1.PP 1:200

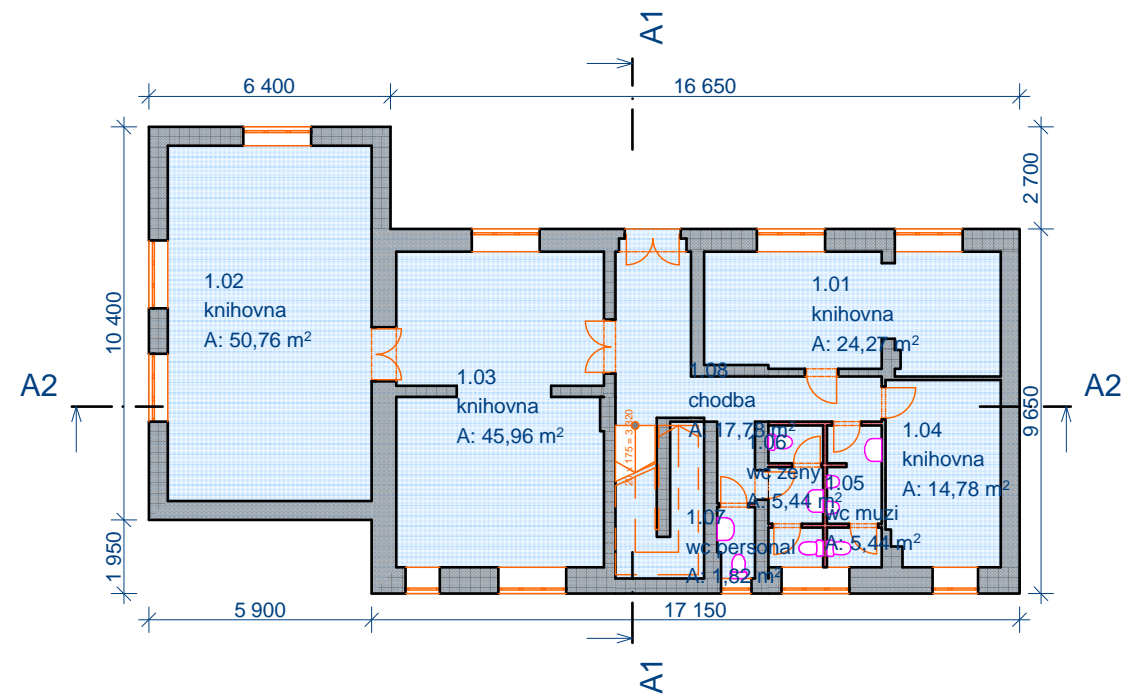

1. 1.NP 1:200

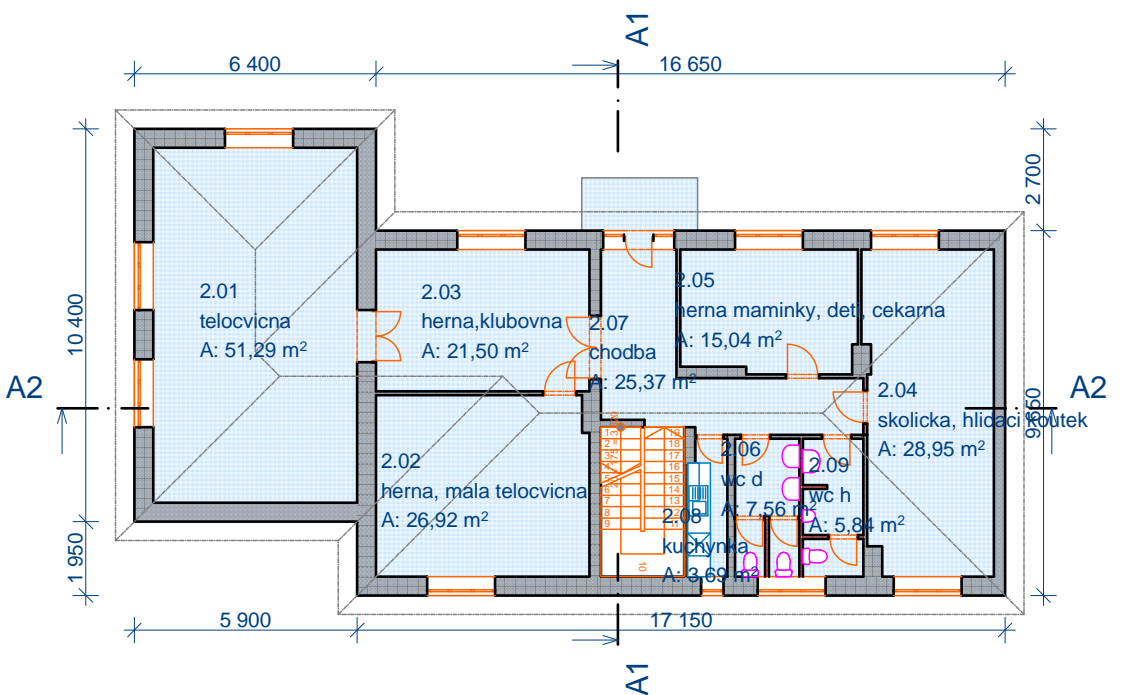

2. 2.NP 1:200

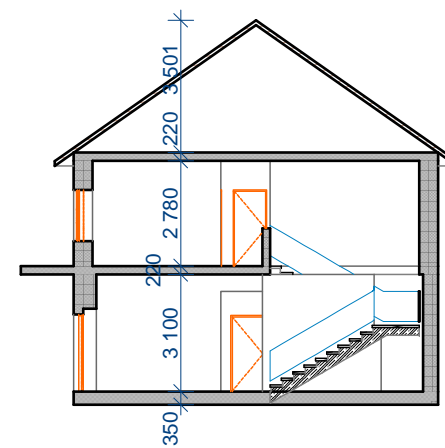

A1 Řez A-A' 1:200 A2

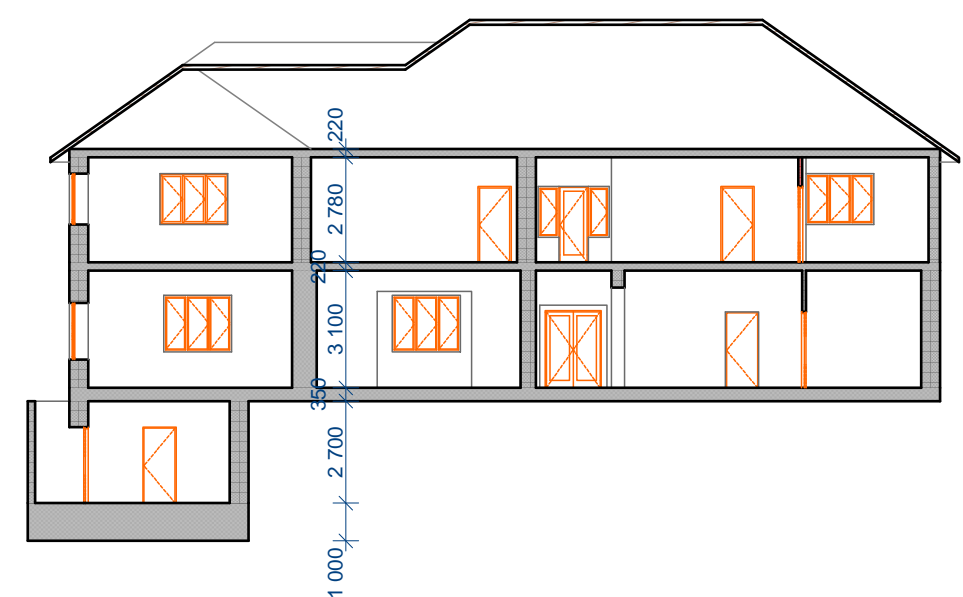

A2 Řez A-A' 1:200

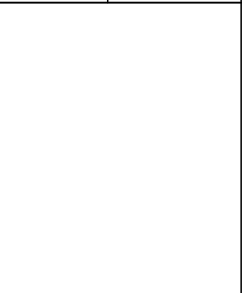

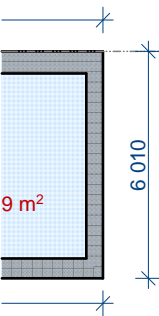
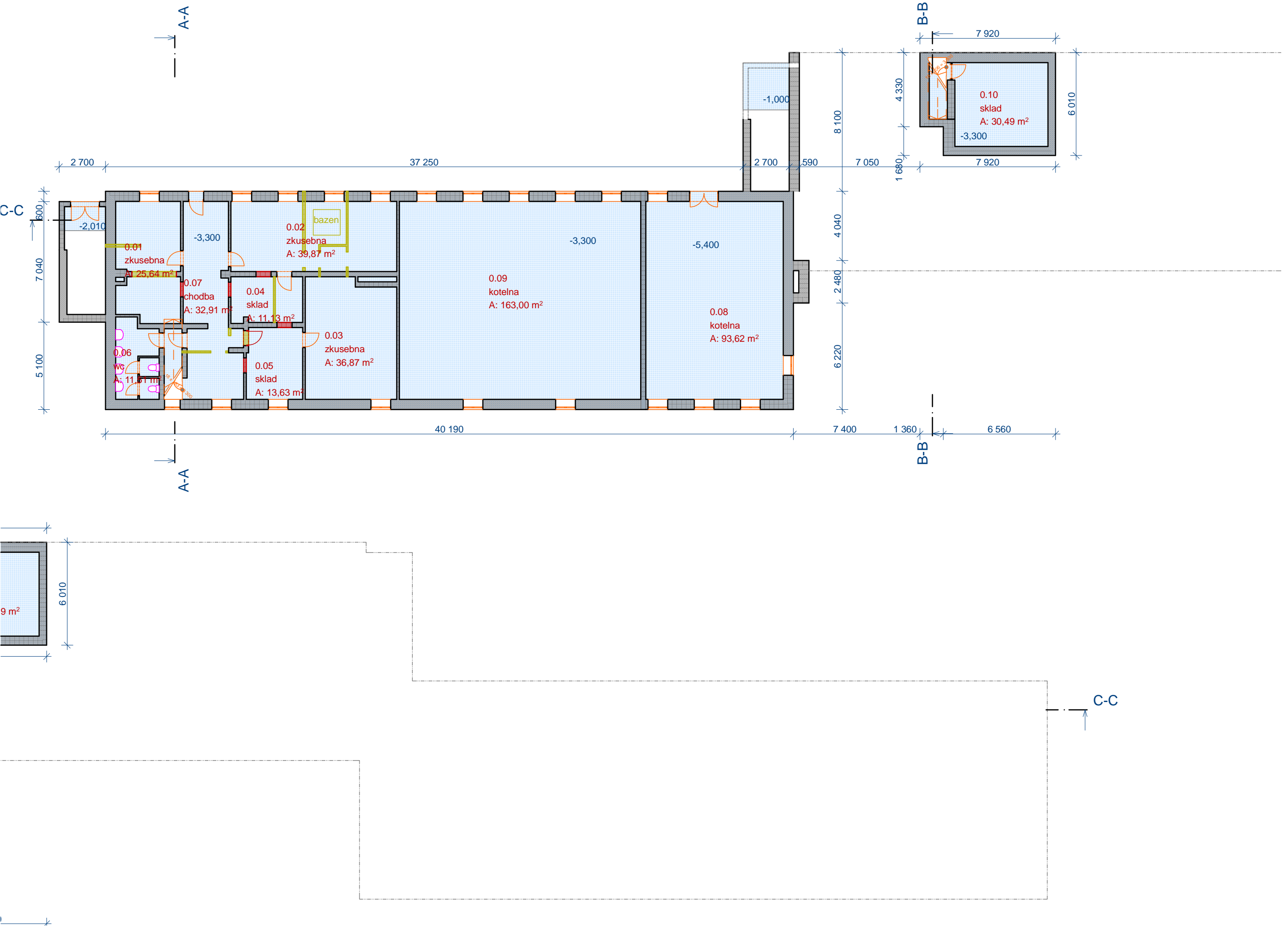
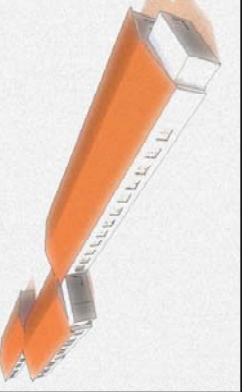



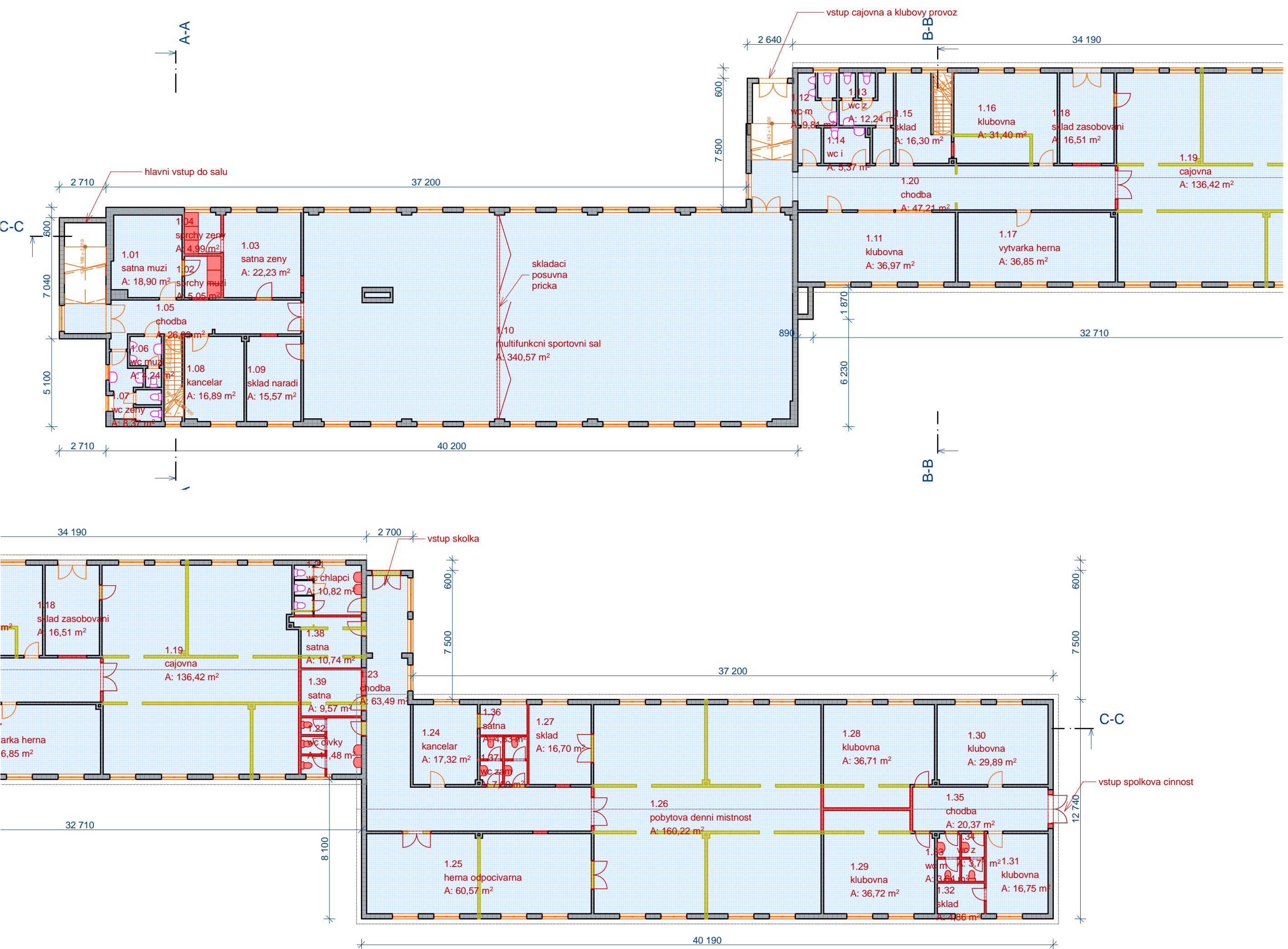

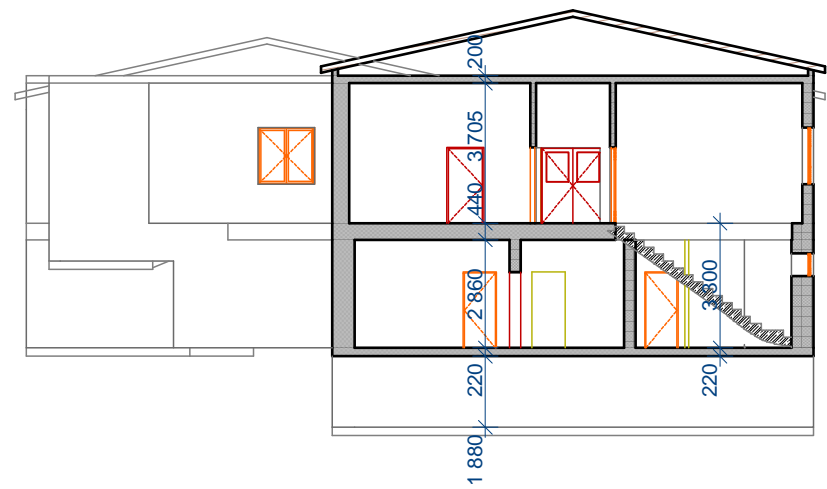

A-A' Řez A-A' 1:200

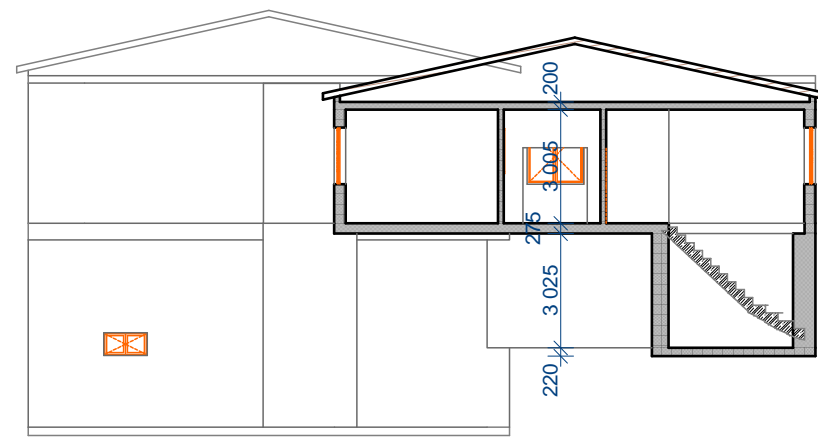

B-B Řez A-A' 1:200

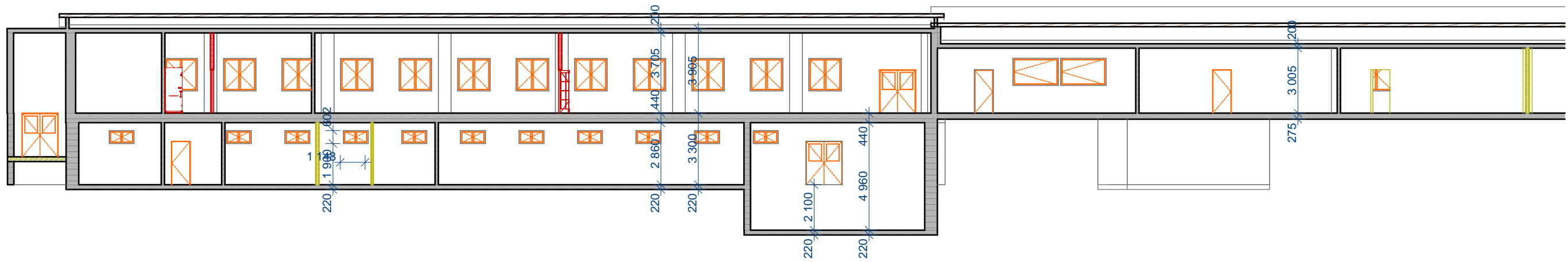

C-C Řez A-A' 1:200

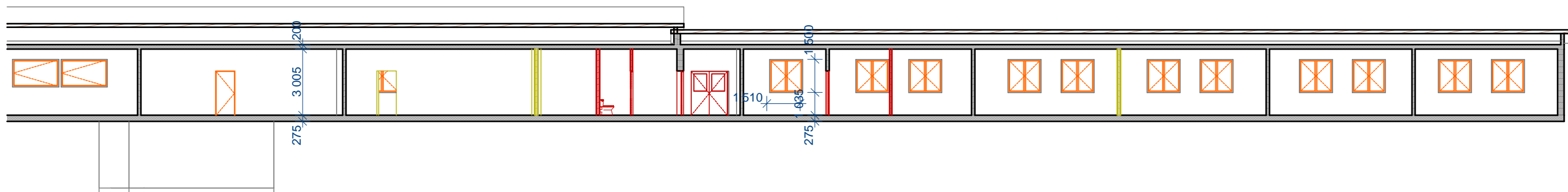

C-C Řez A-A' 1:200

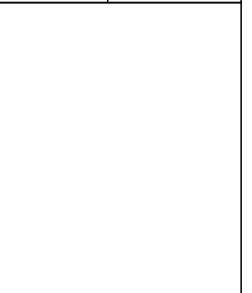
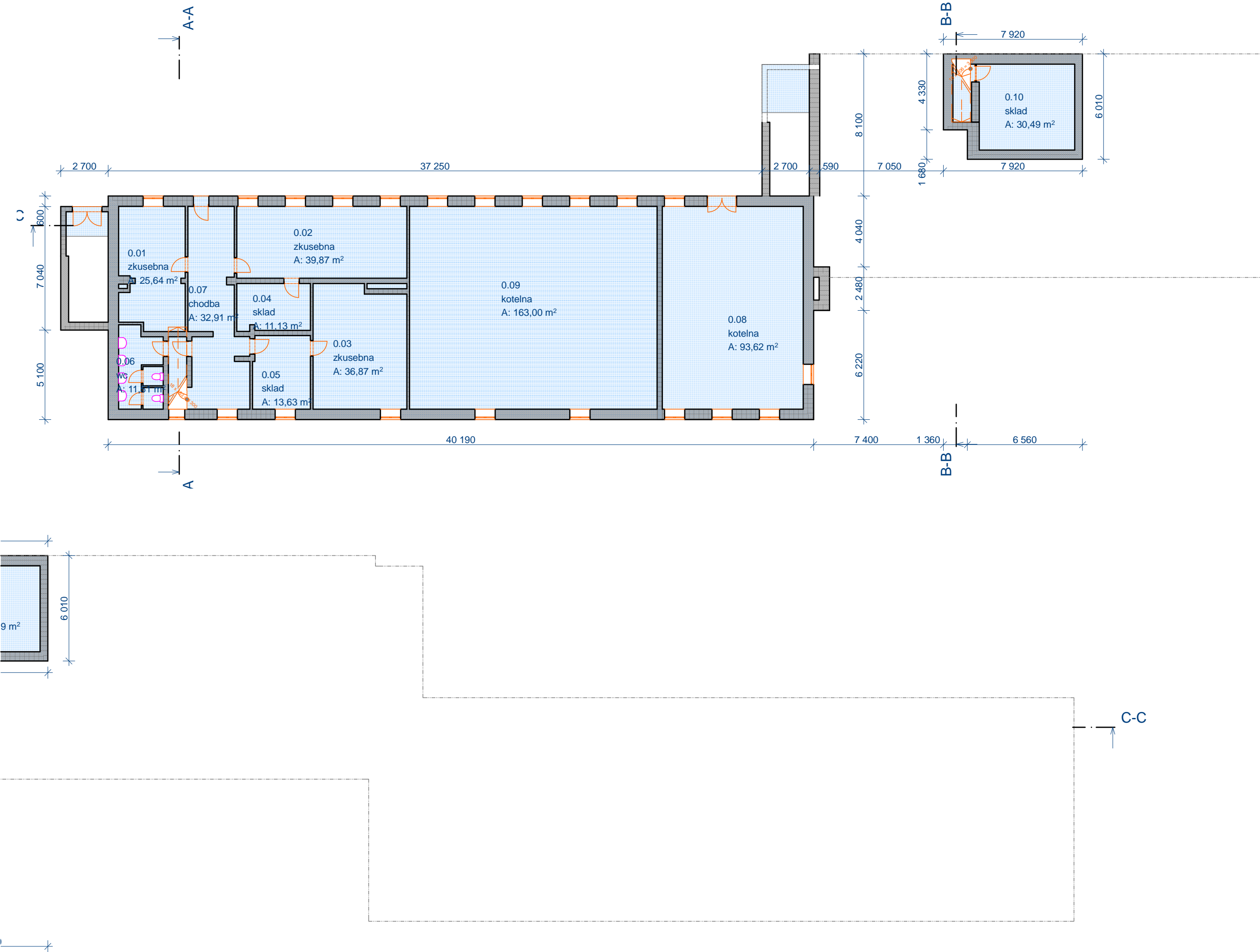

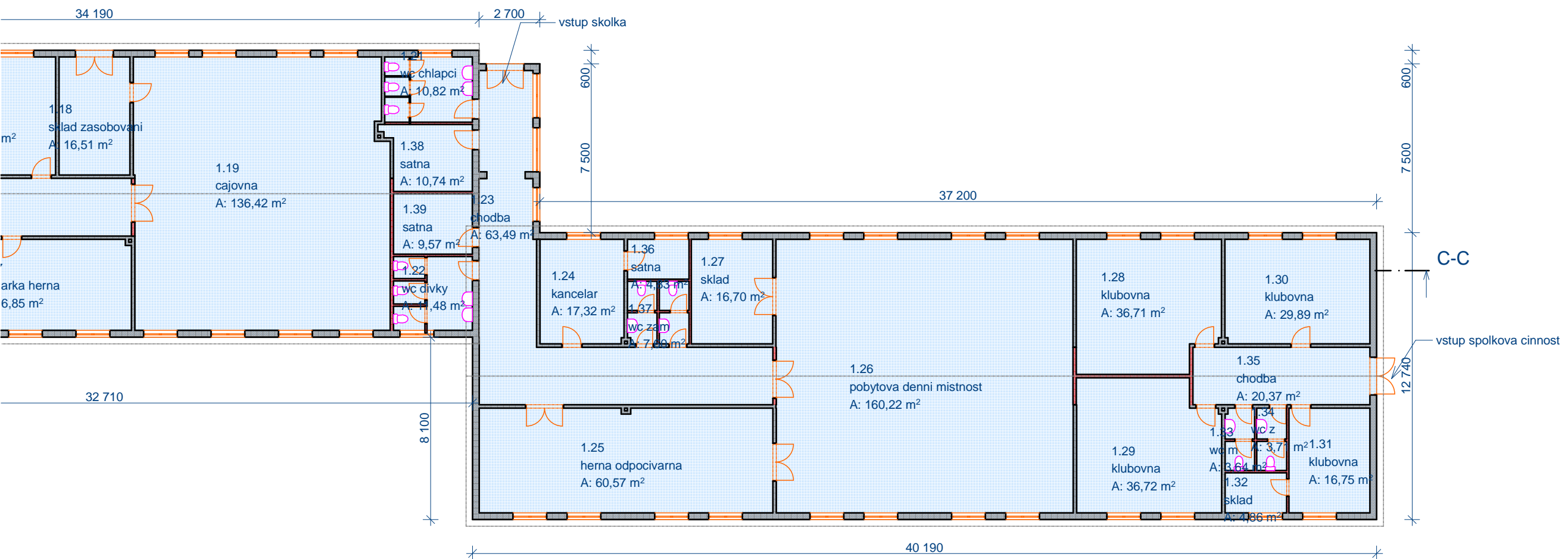
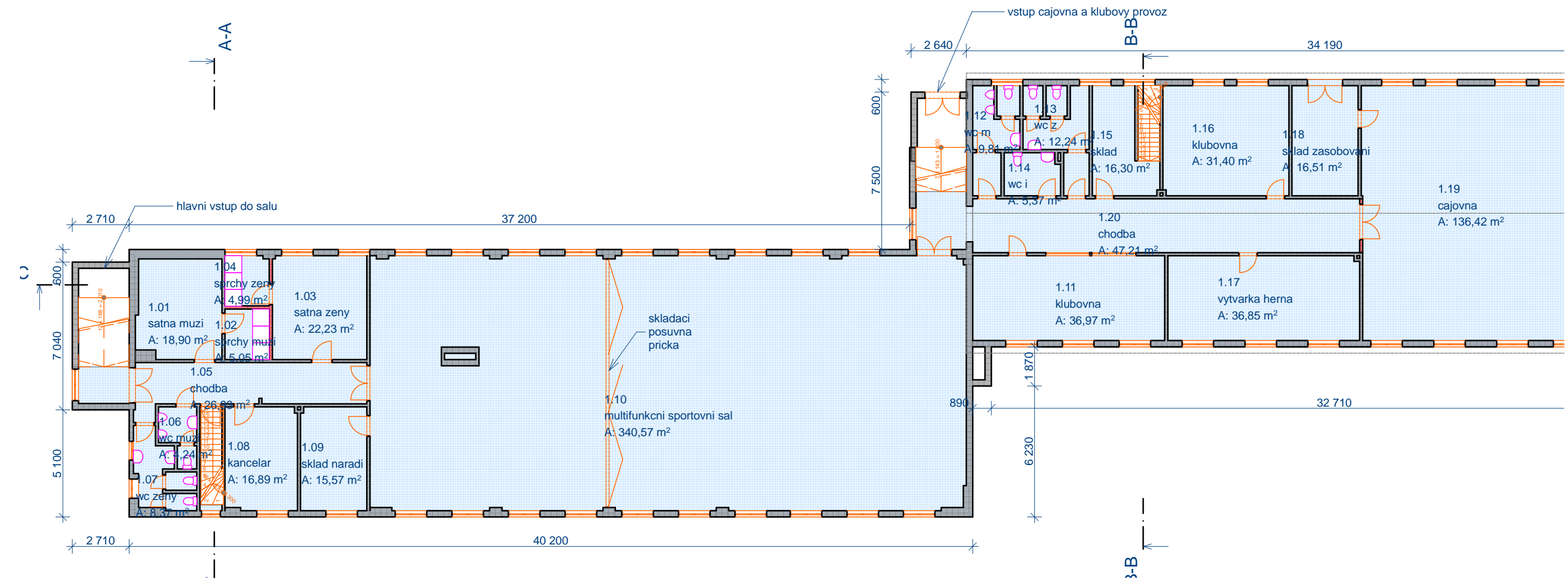

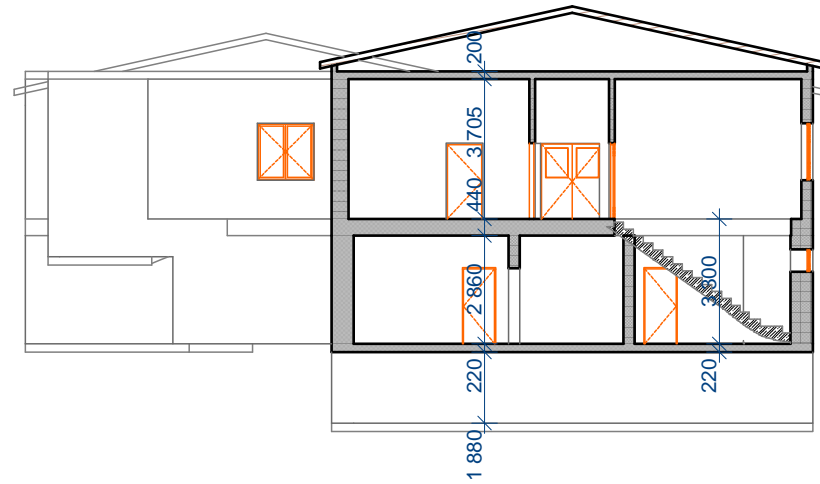
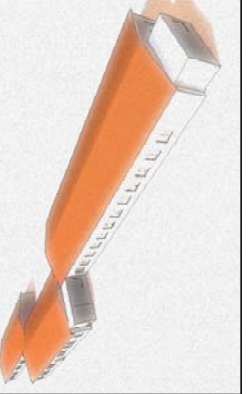

A-A' Řez A-A' 1:200

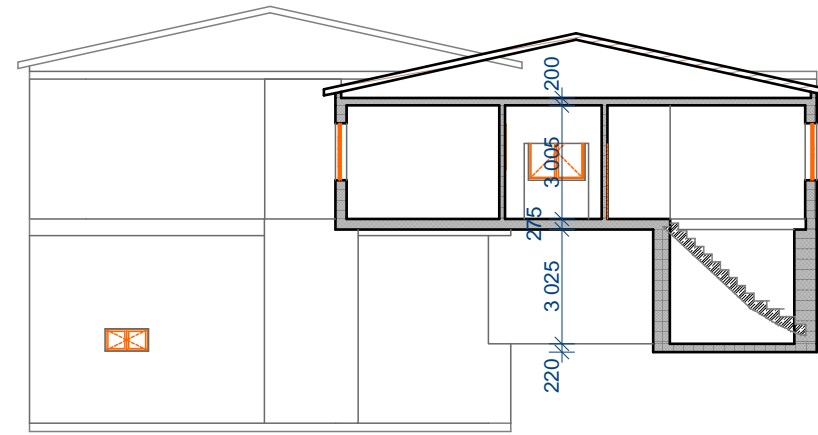

B-B Řez A-A' 1:200

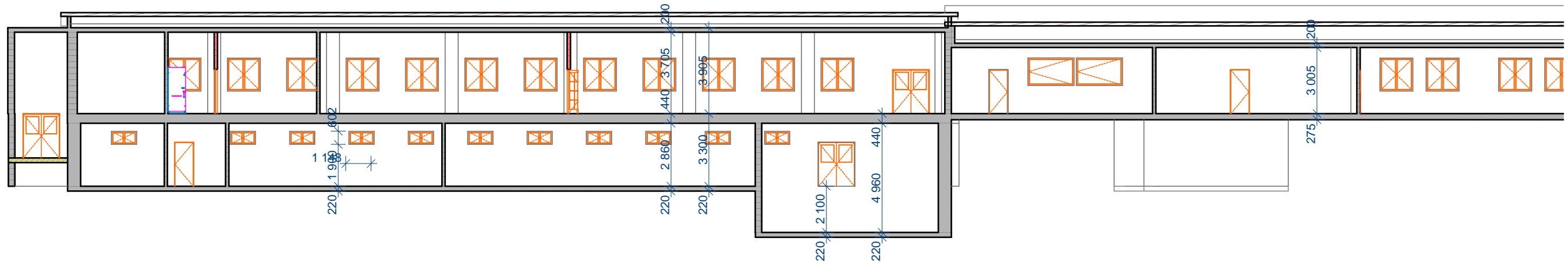

C-C Řez A-A' 1:200

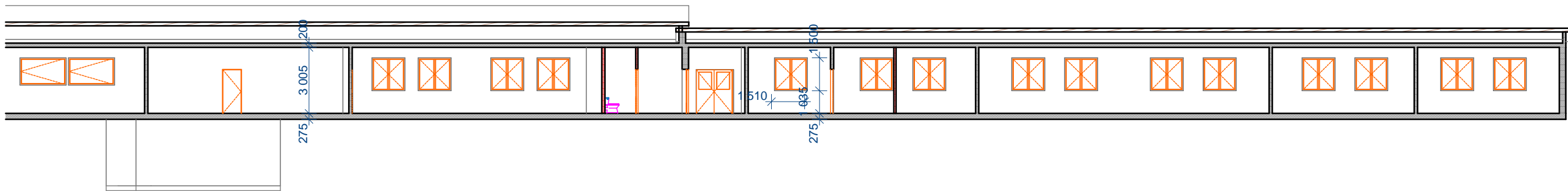

C-C Řez A-A' 1:200

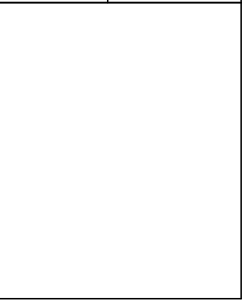
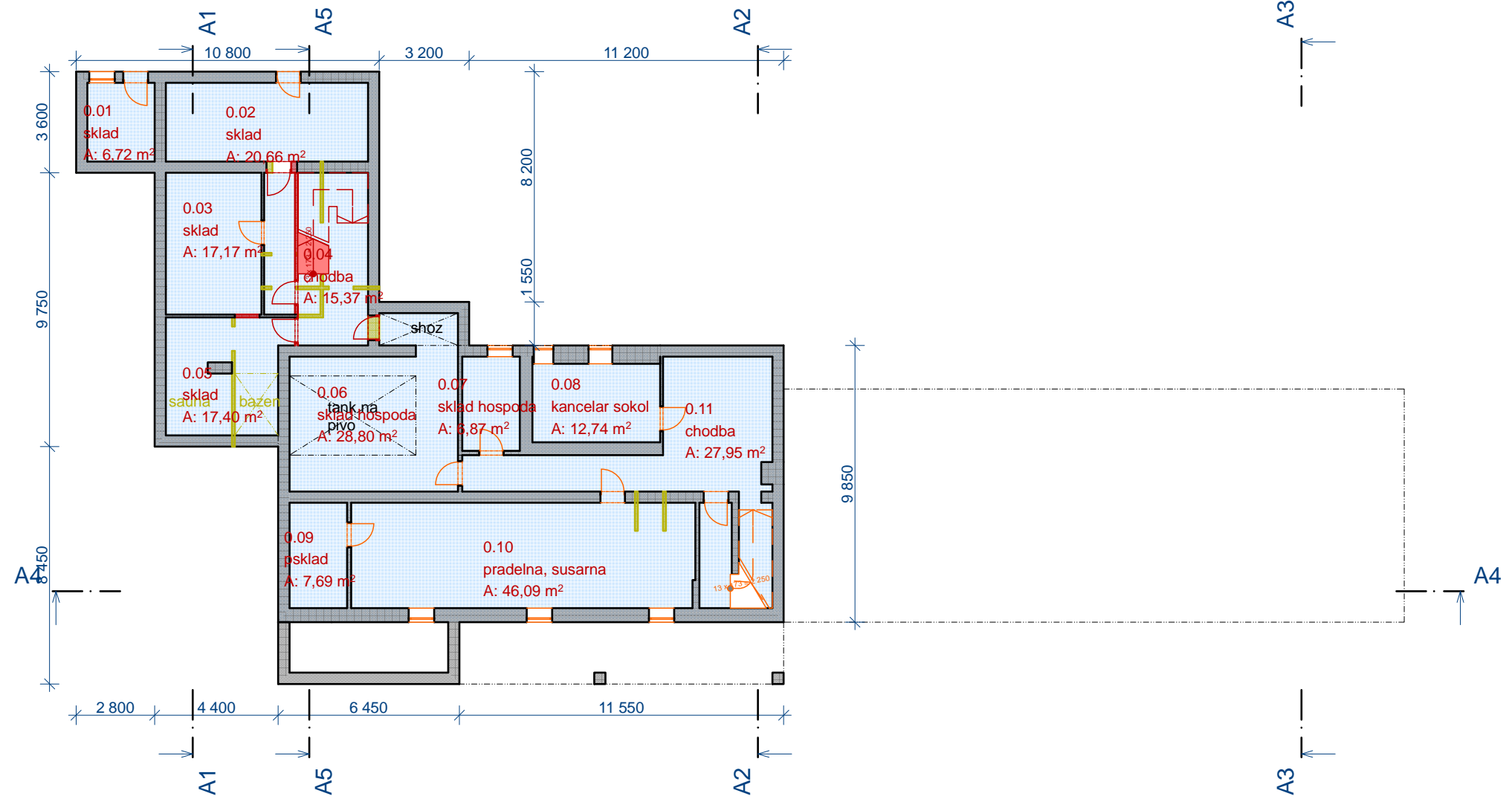
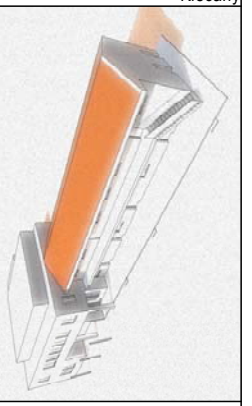

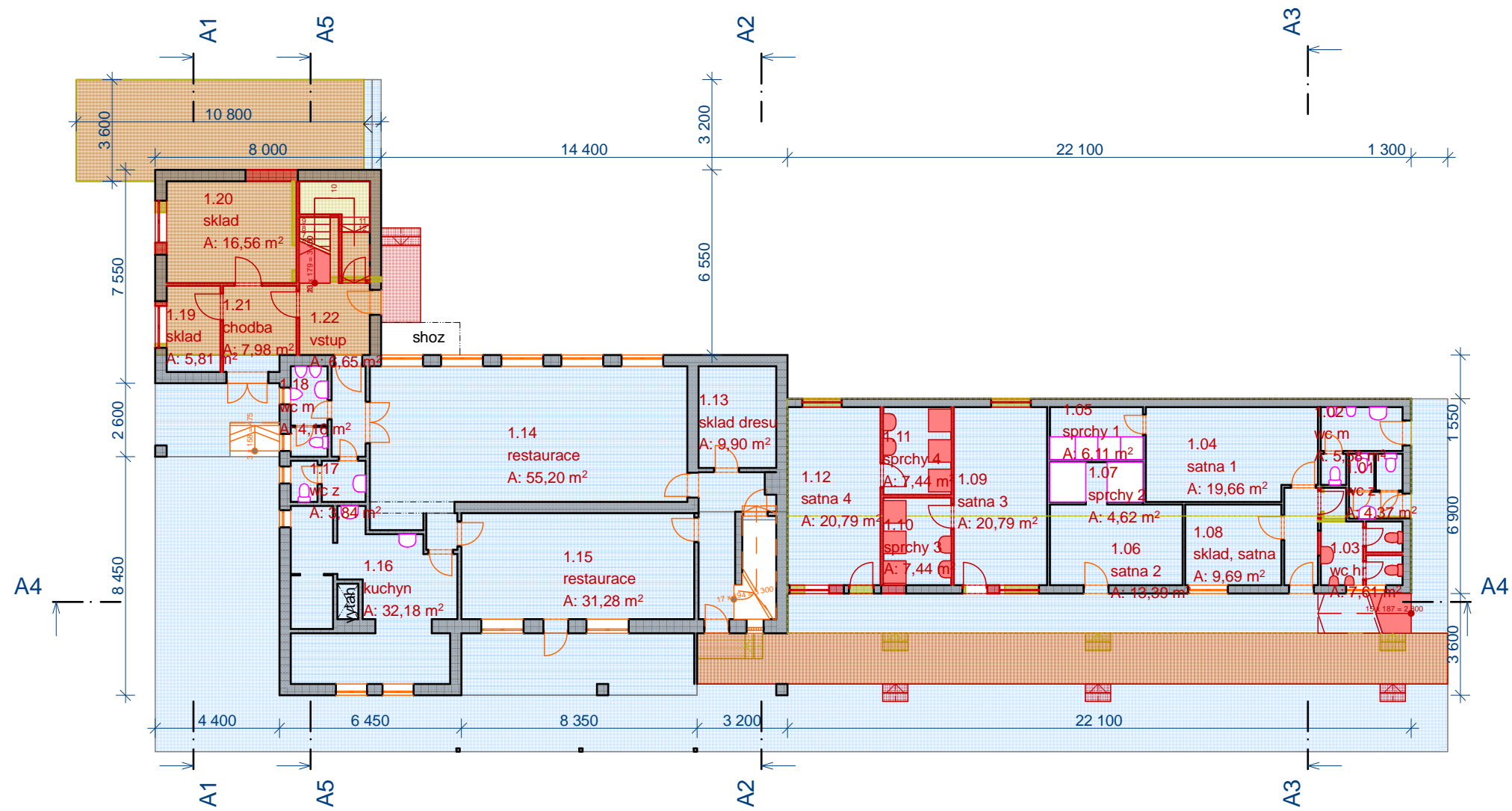
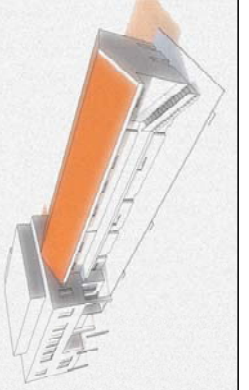

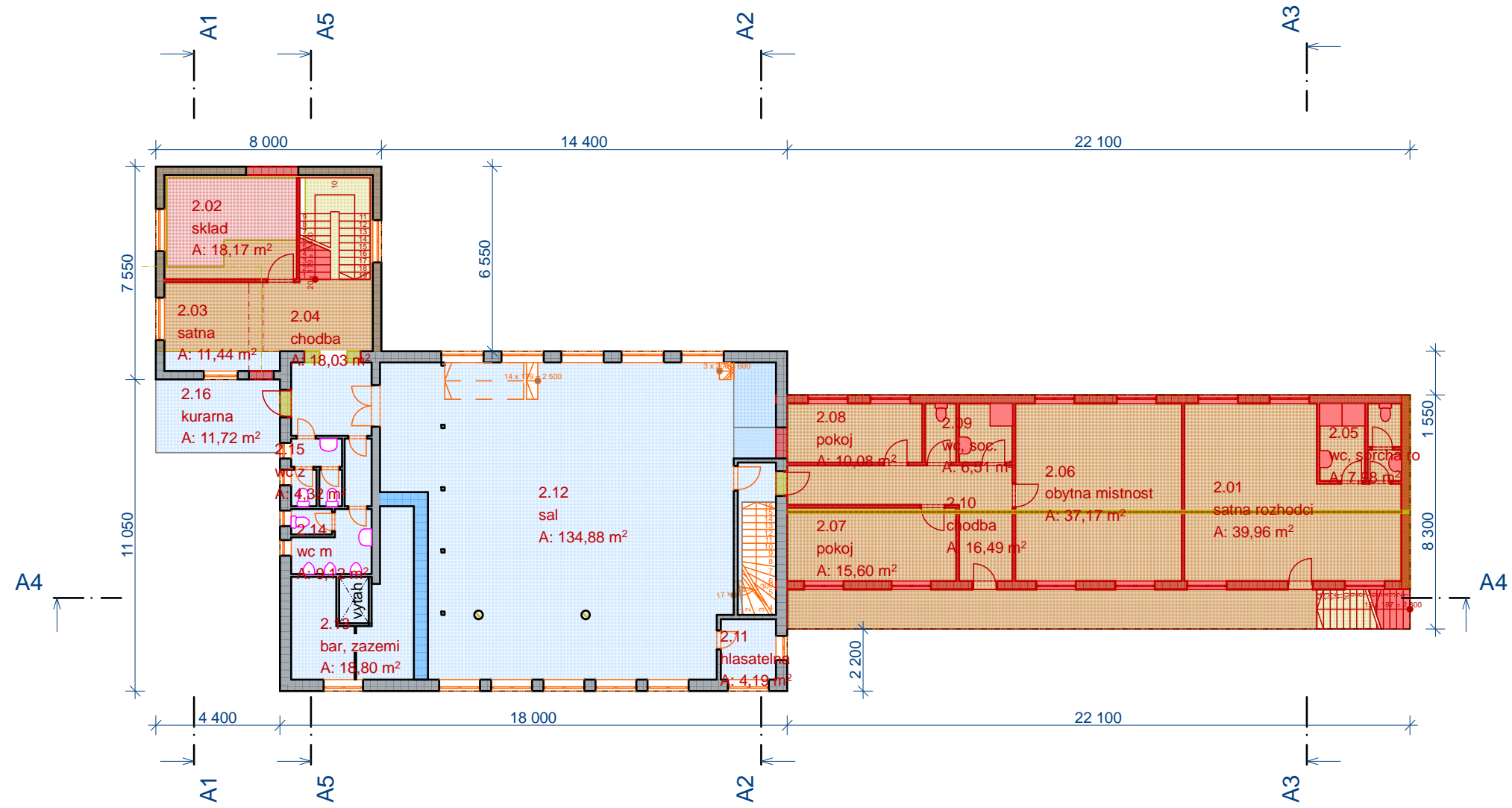
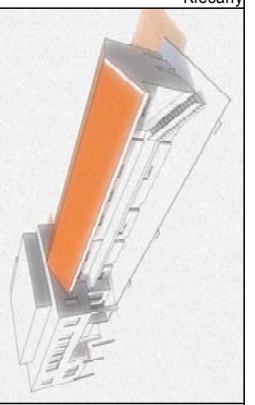



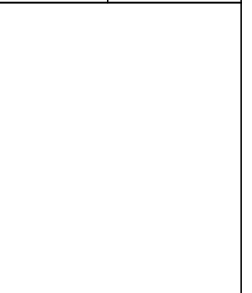
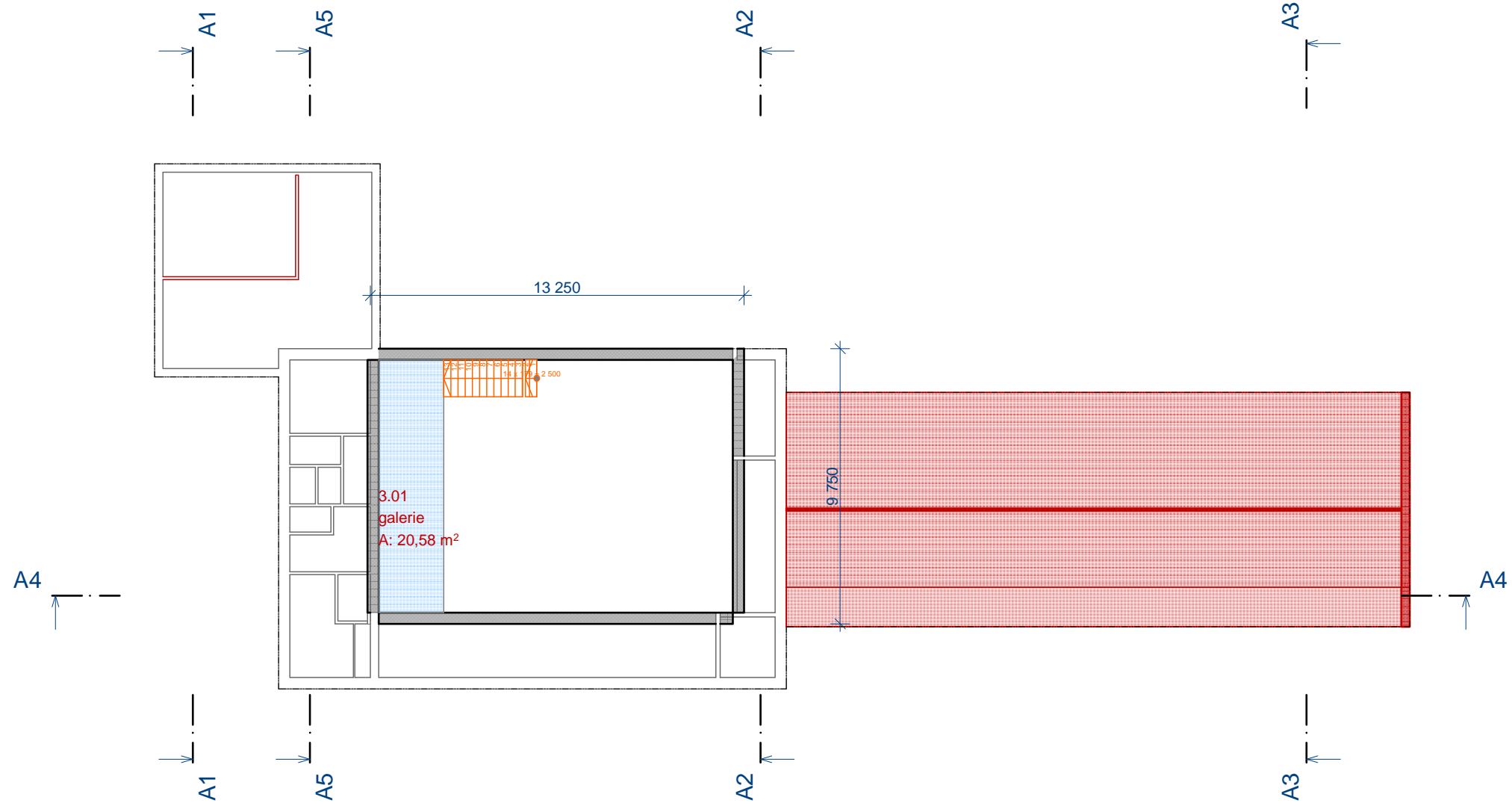
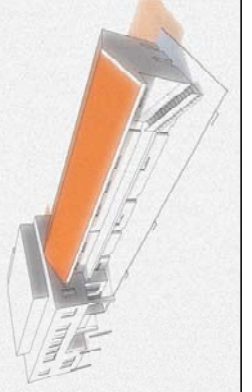

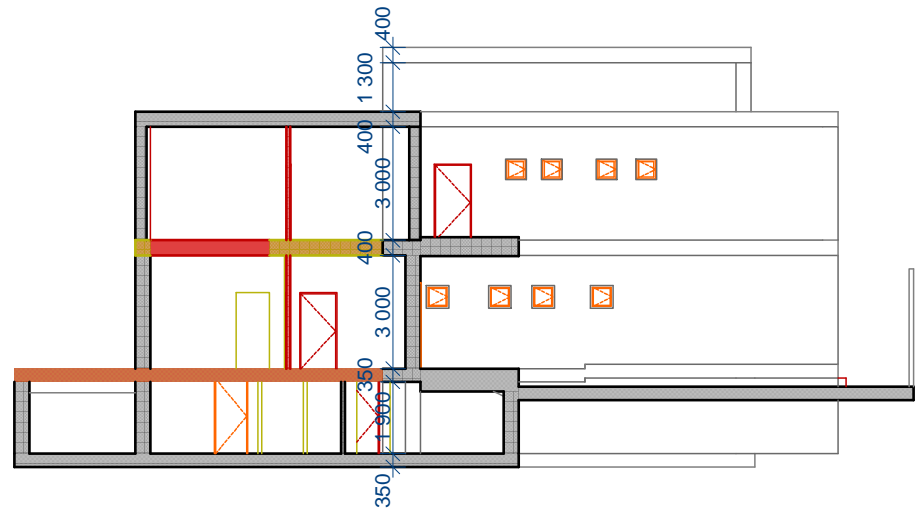
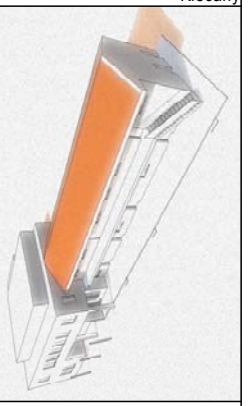

A1 Řez A-A' 1:200

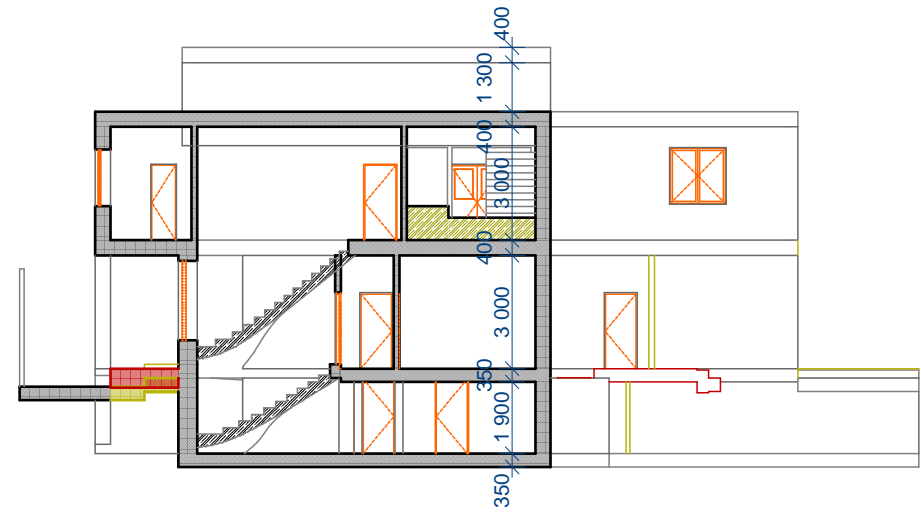

A2 Řez A-A' 1:200

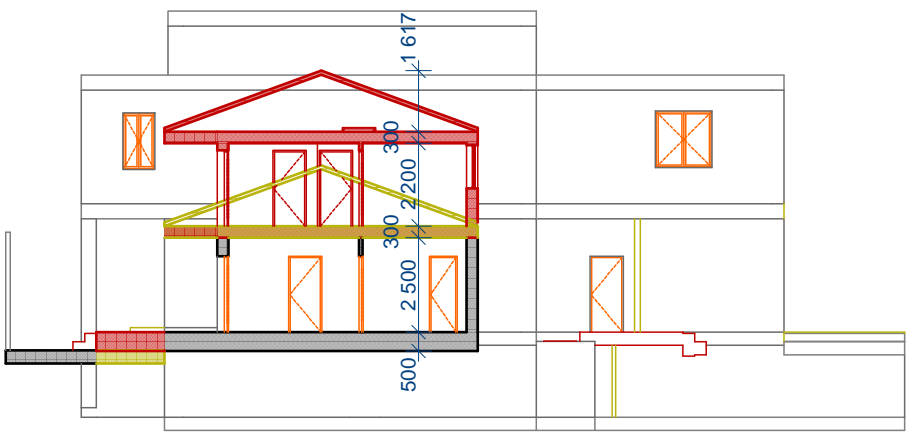

A3 Řez A-A' 1:200

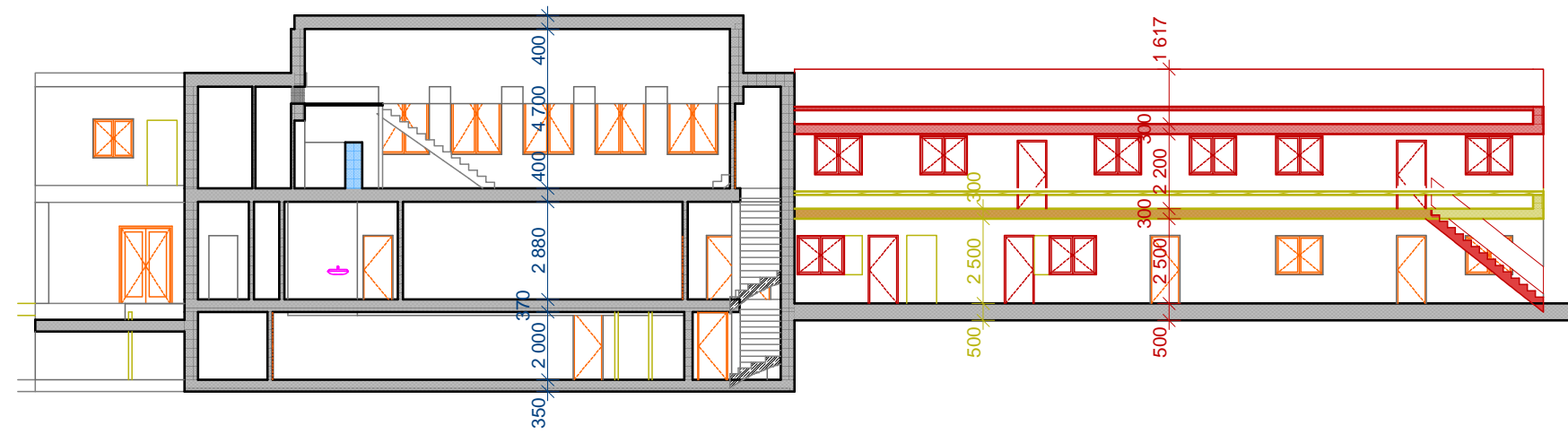

A4 Řez A-A' 1:200

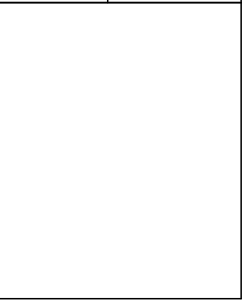
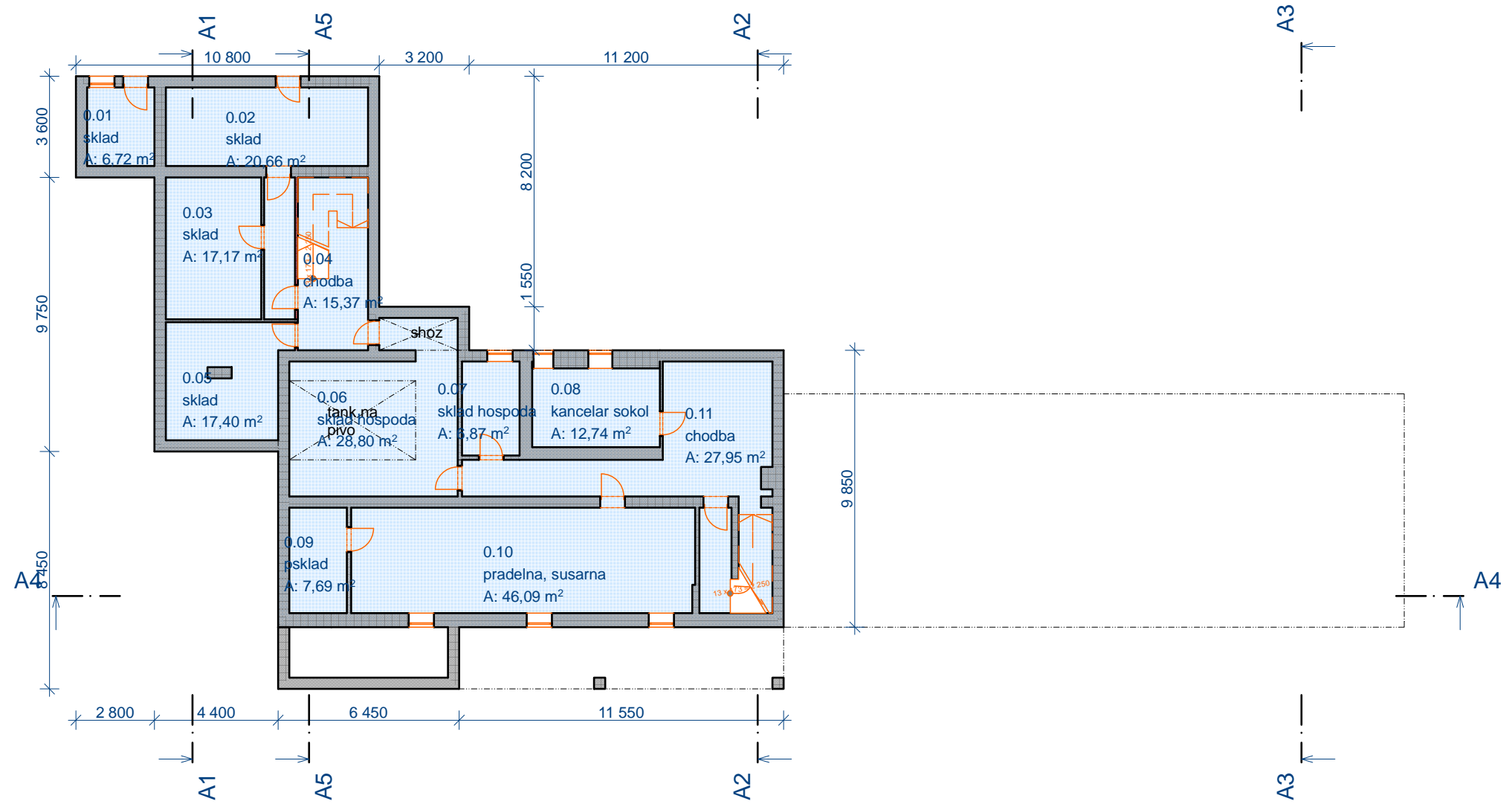
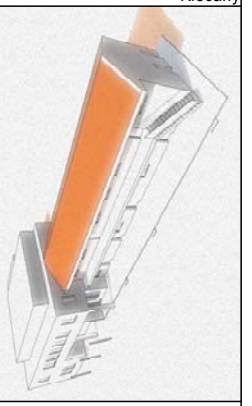

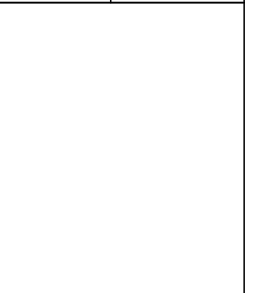
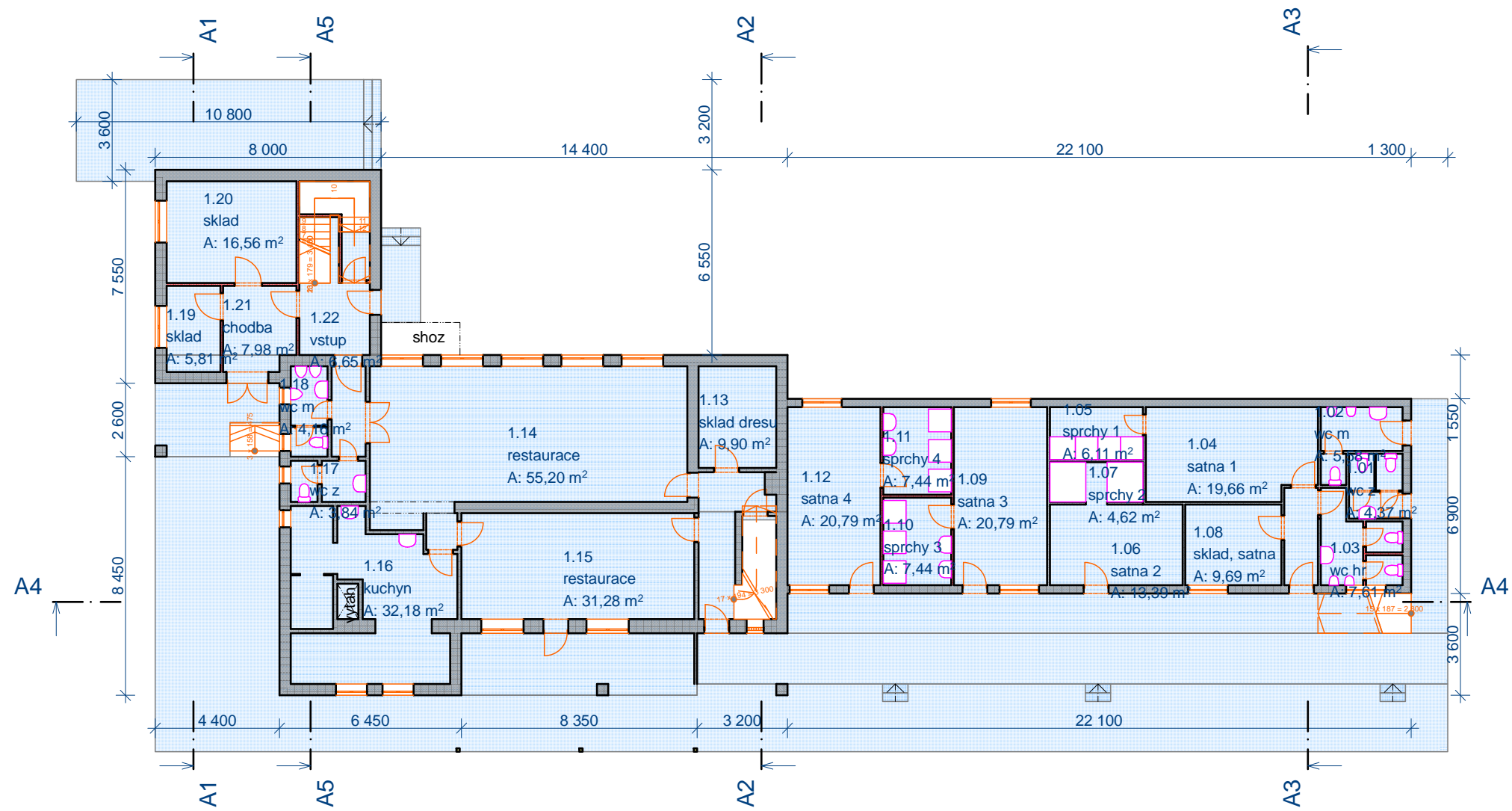
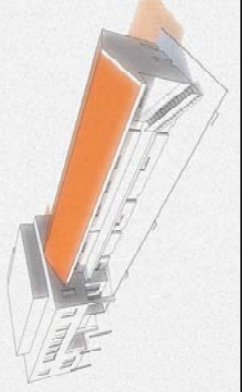

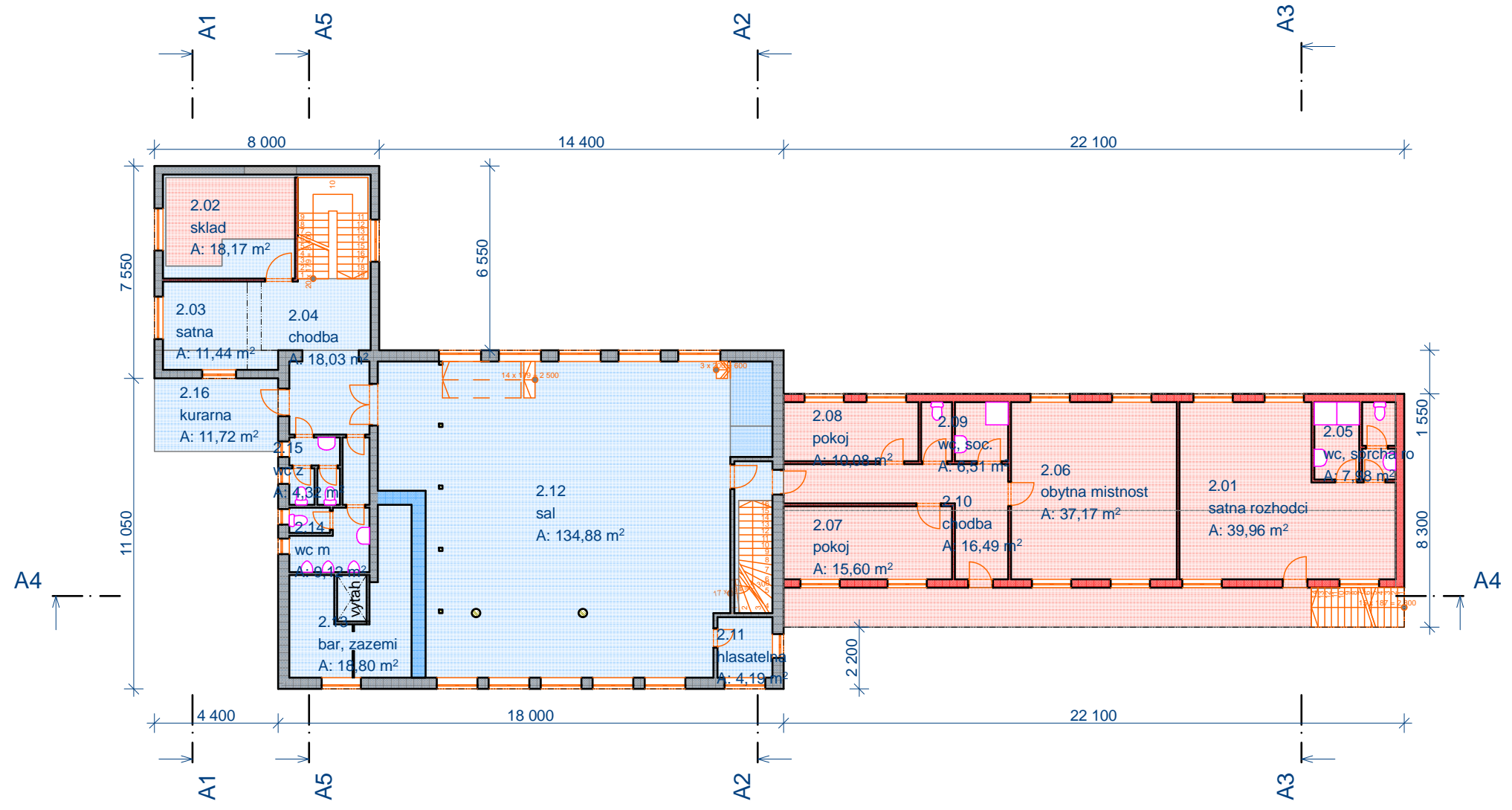
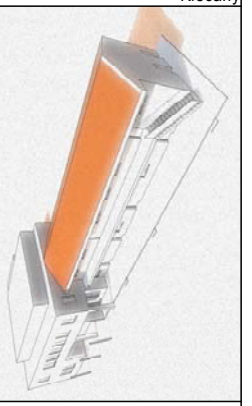

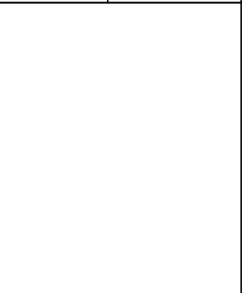
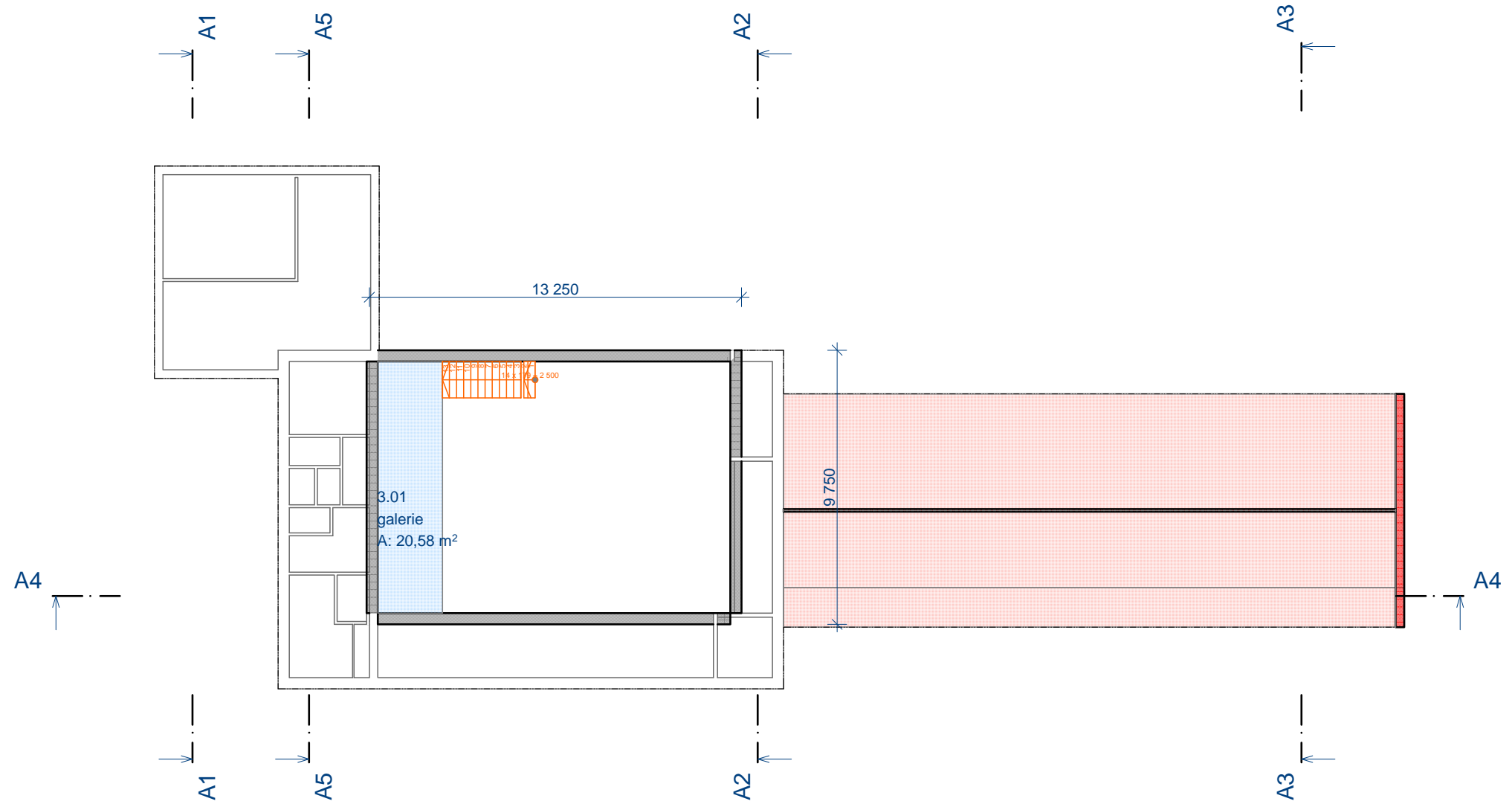
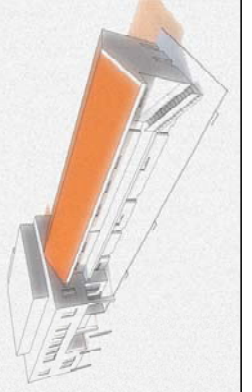

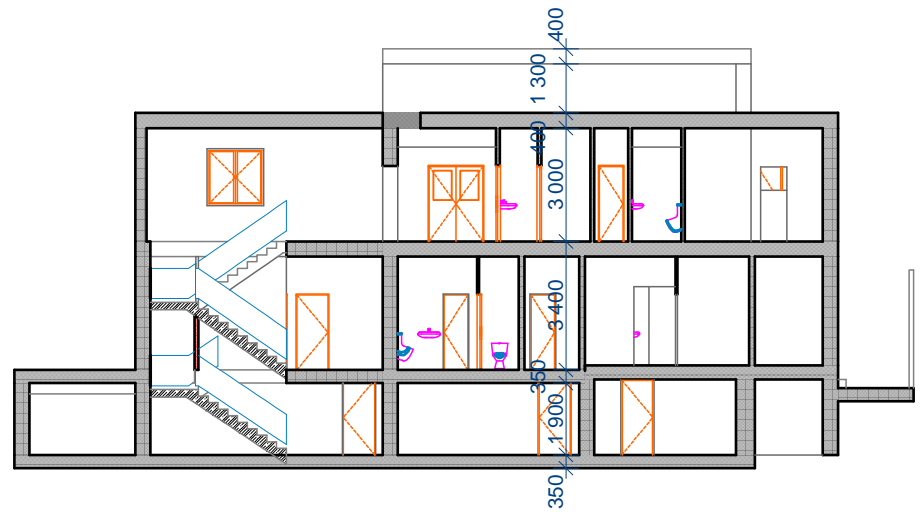
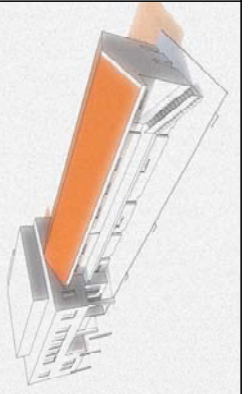

A5 Řez A-A' 1:200

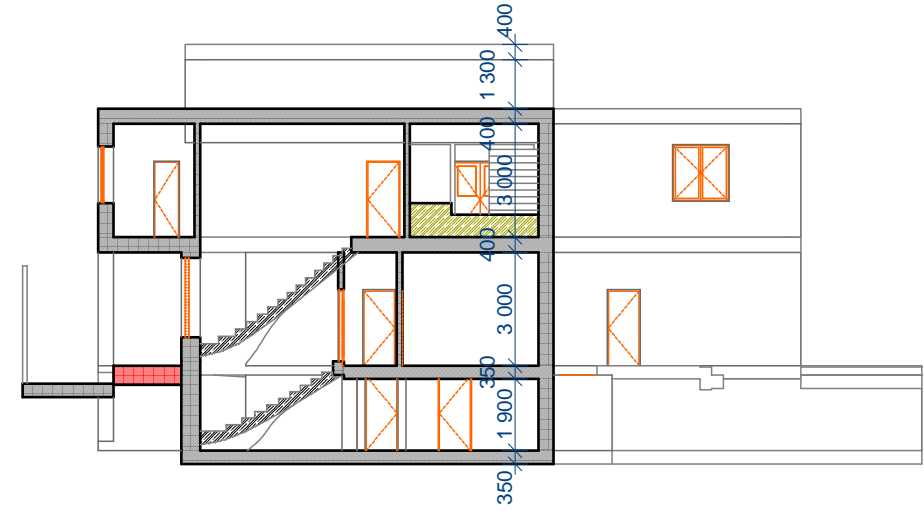

A2 Řez A-A' 1:200

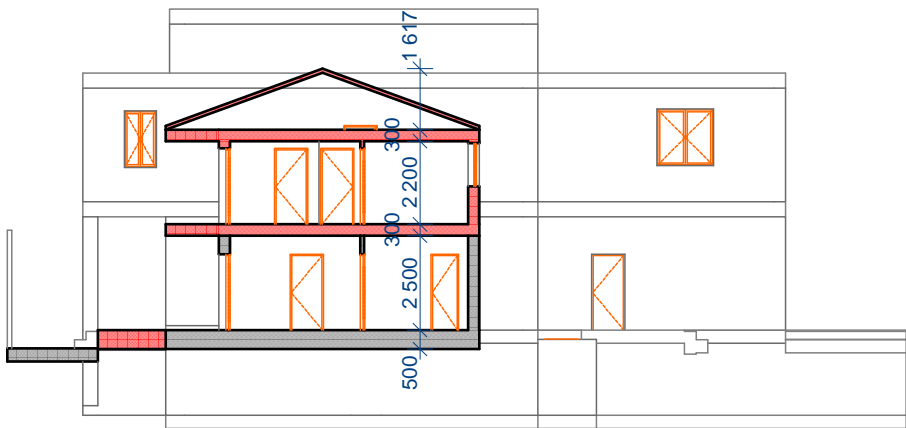

A3 Řez A-A' 1:200

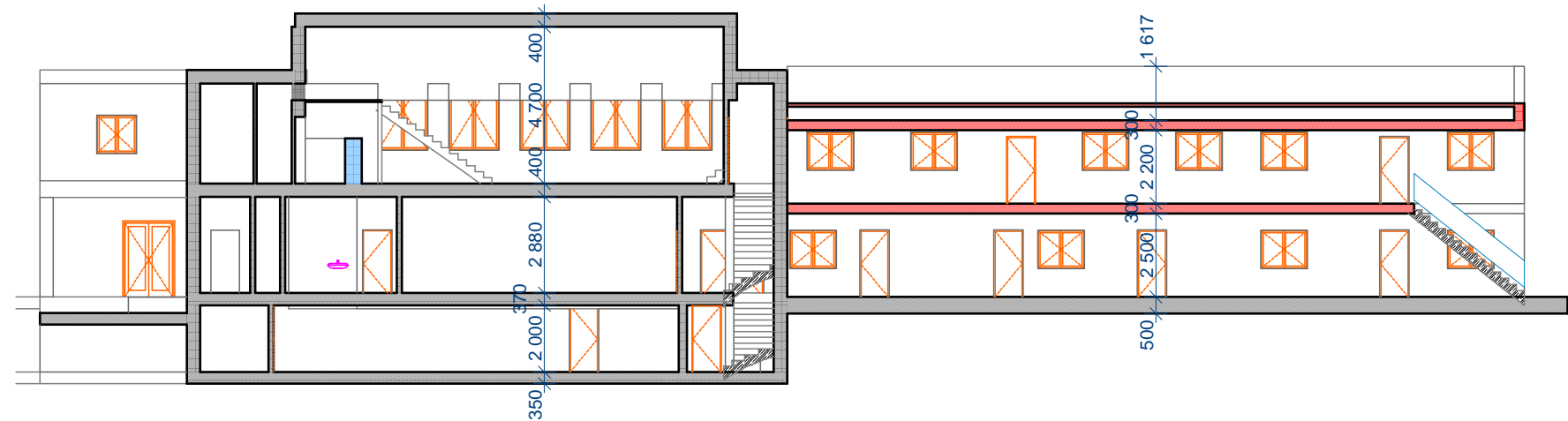

A4 Řez A-A' 1:200

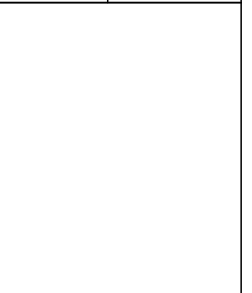

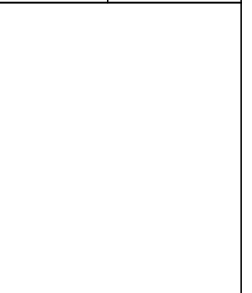
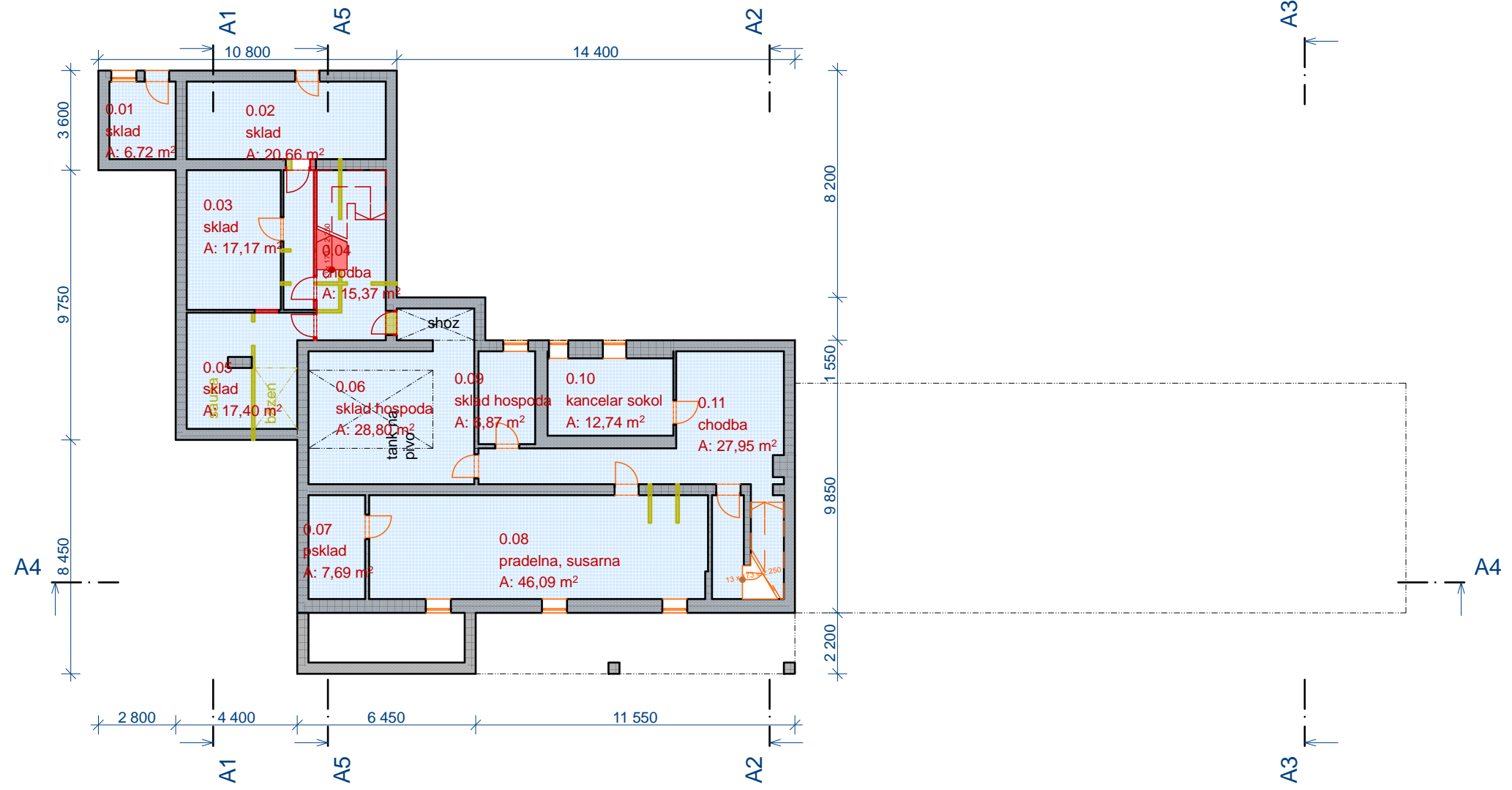
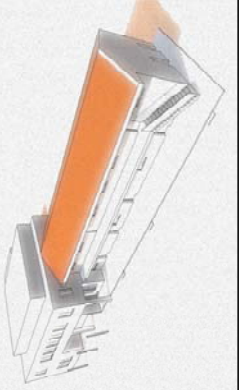



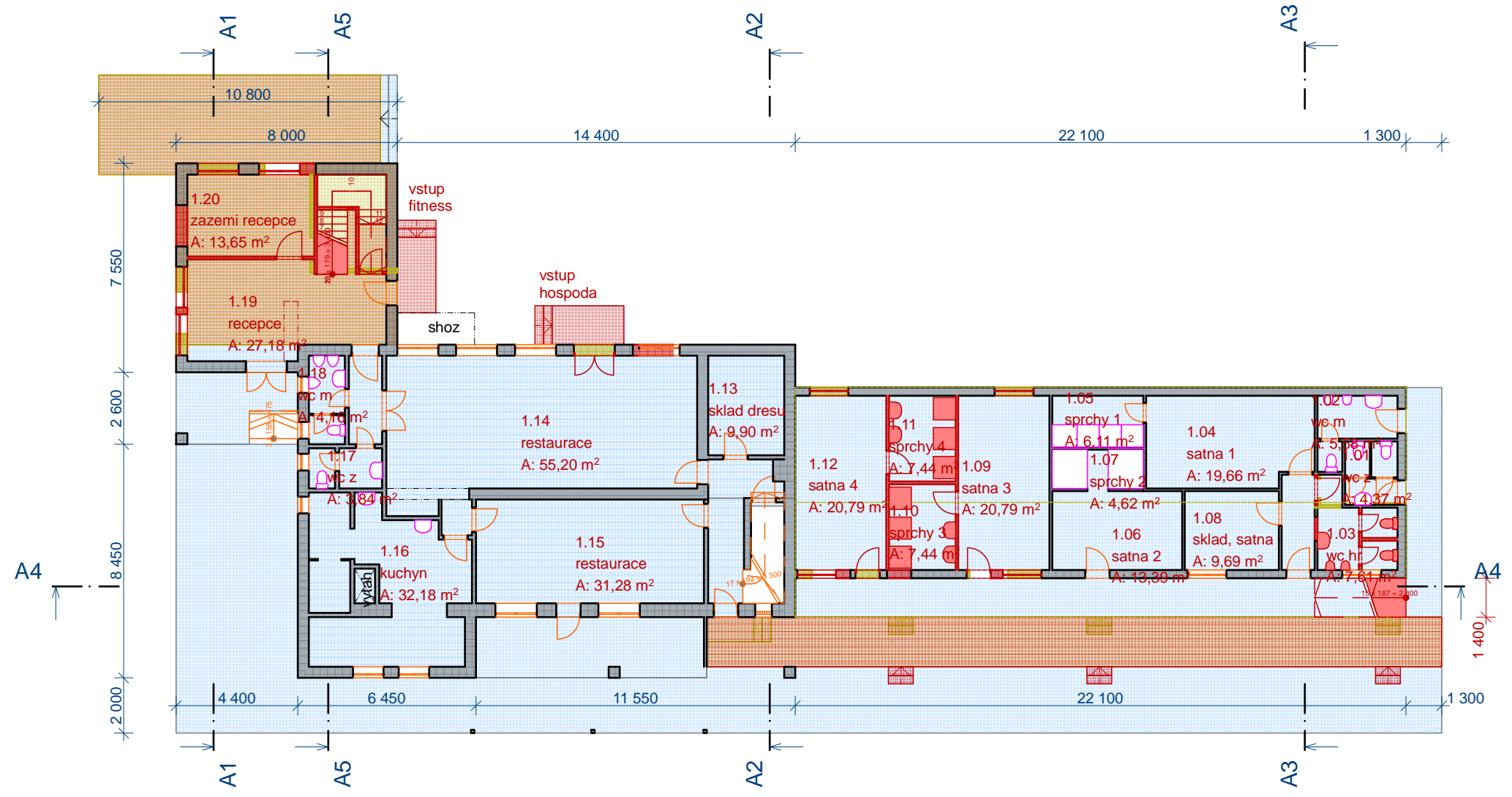
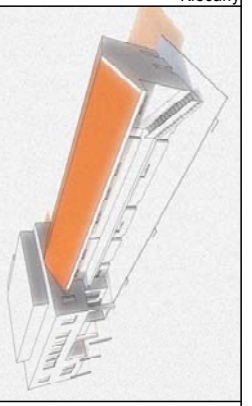

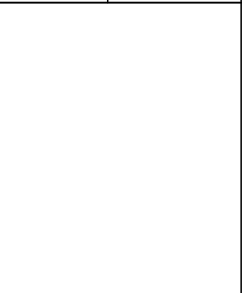
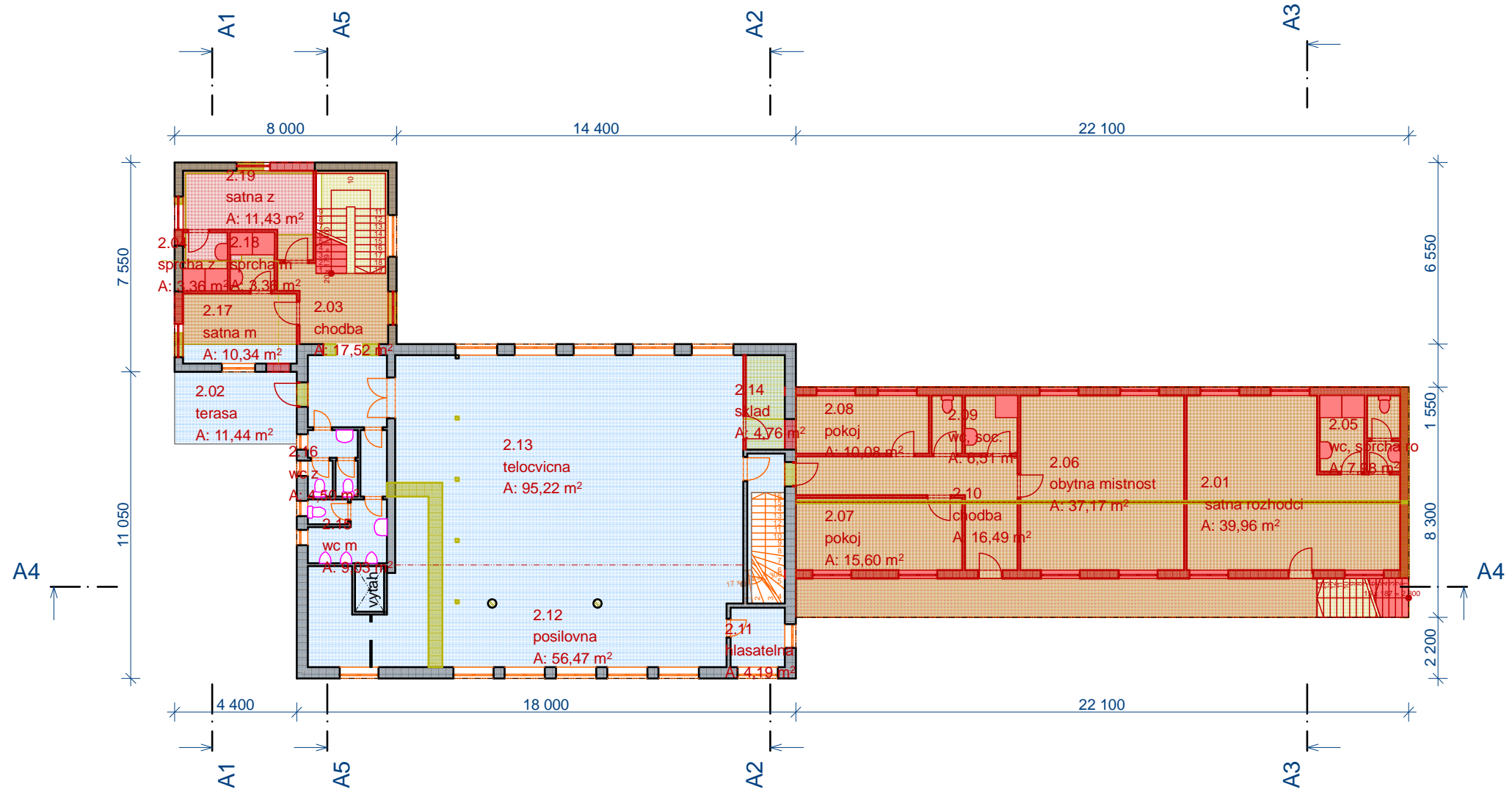
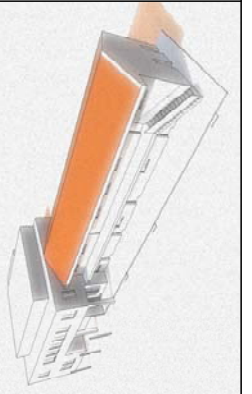

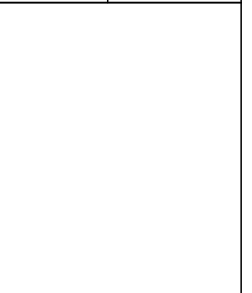
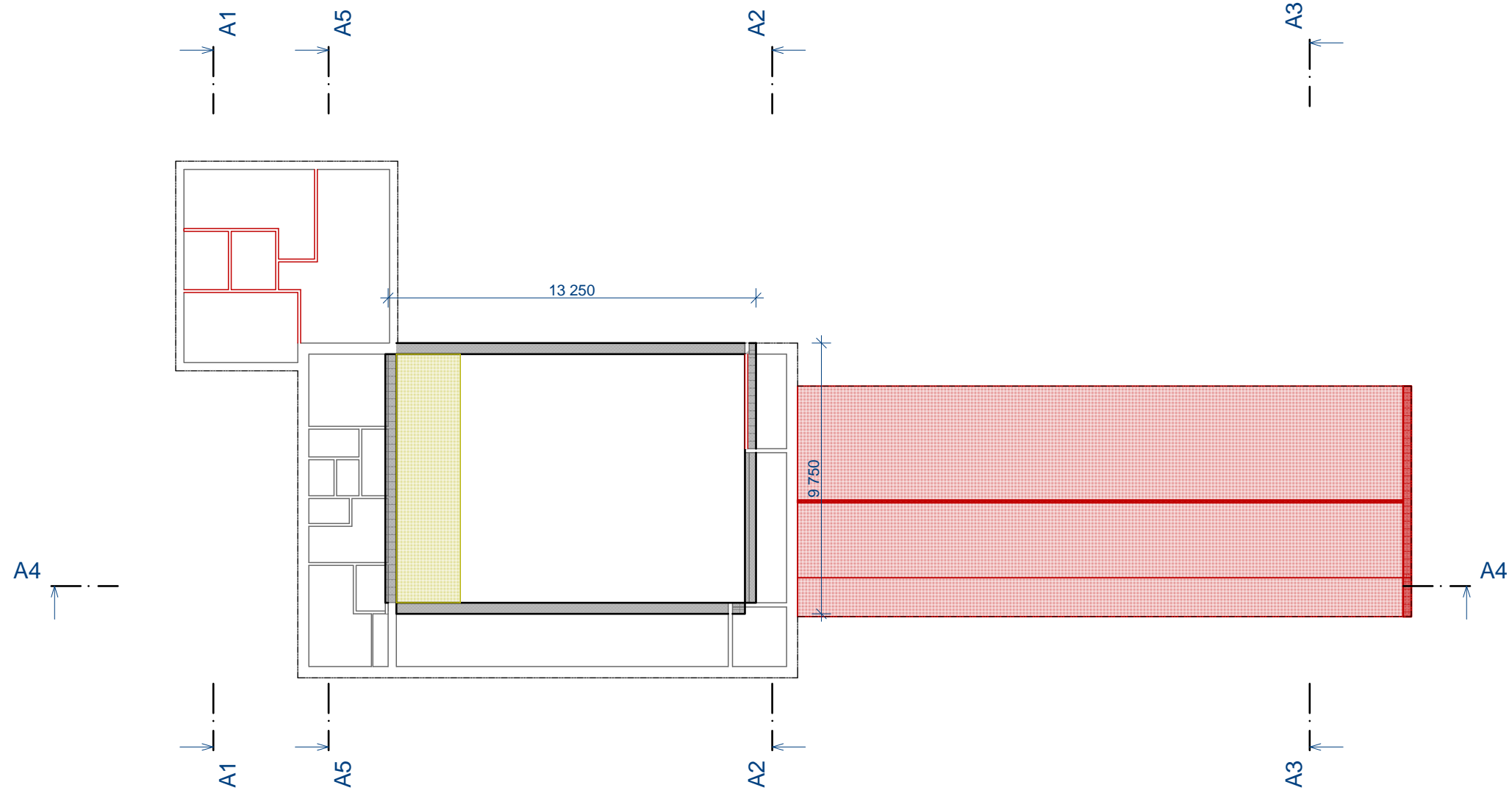
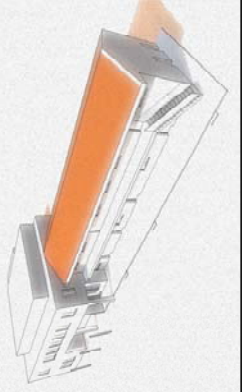

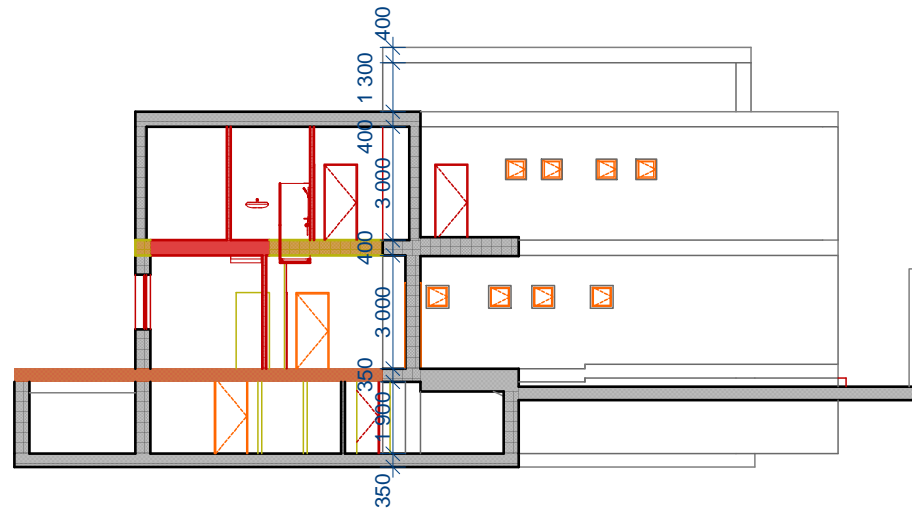
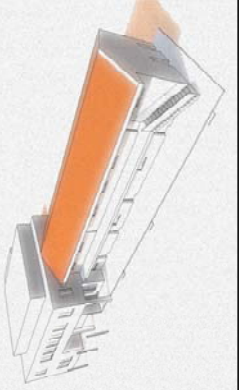

A1 Řez A-A' 1:200

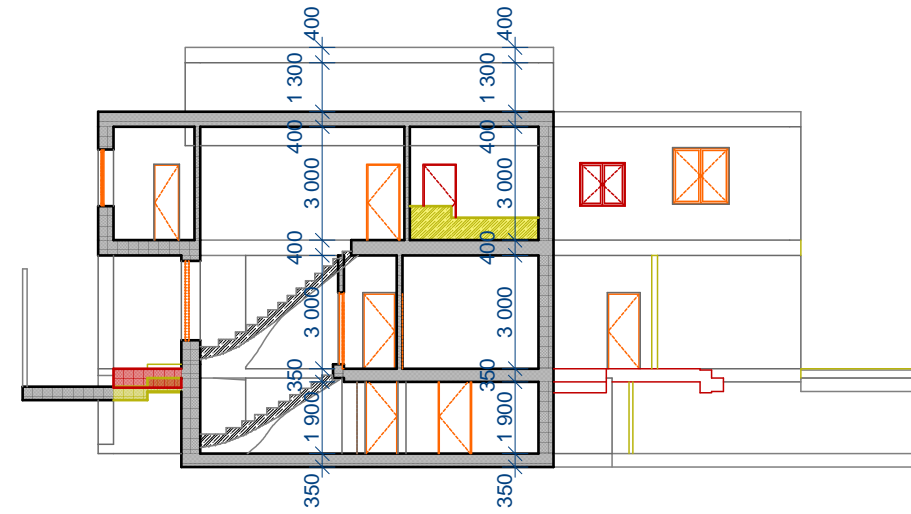

A2 Řez A-A' 1:200

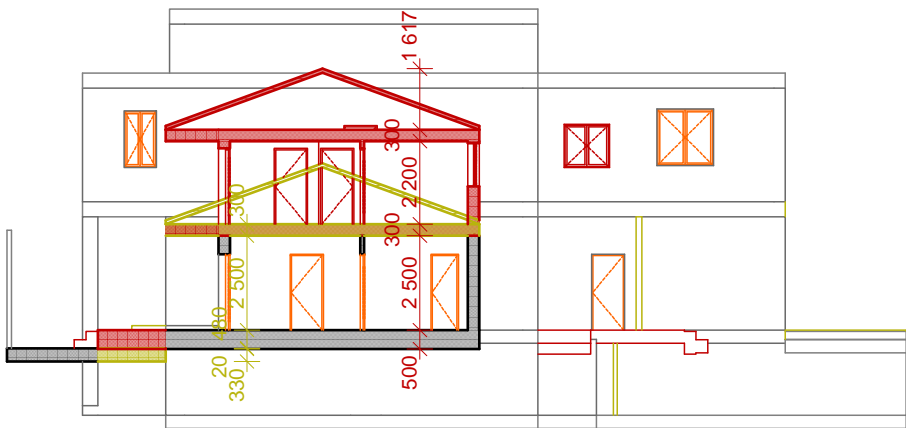

A3 Řez A-A' 1:200

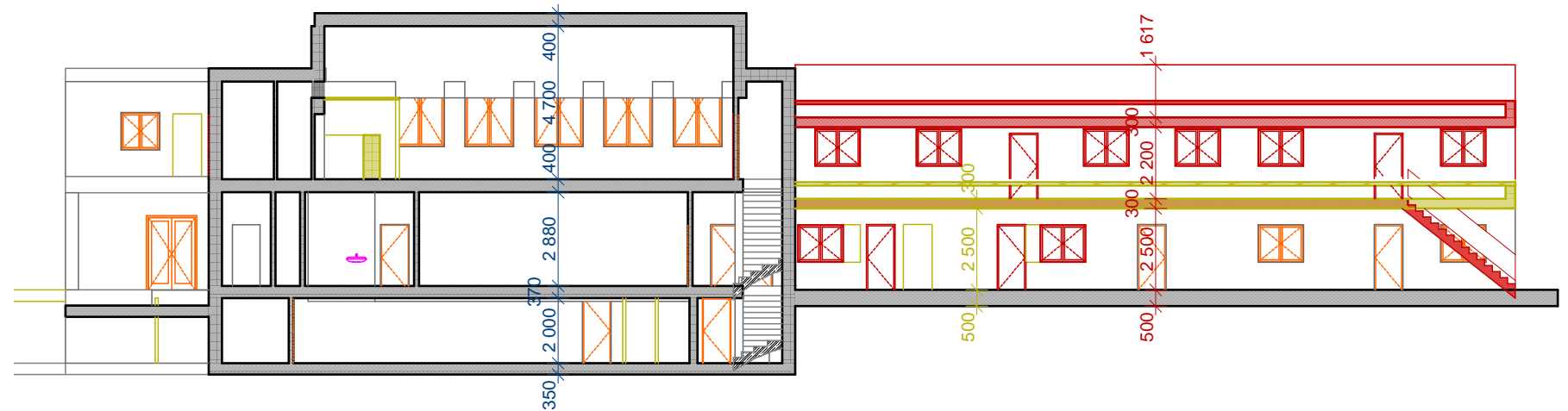

A4 Řez A-A' 1:200

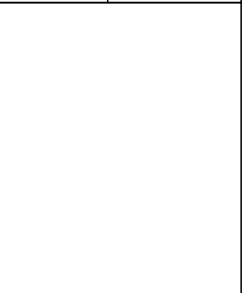
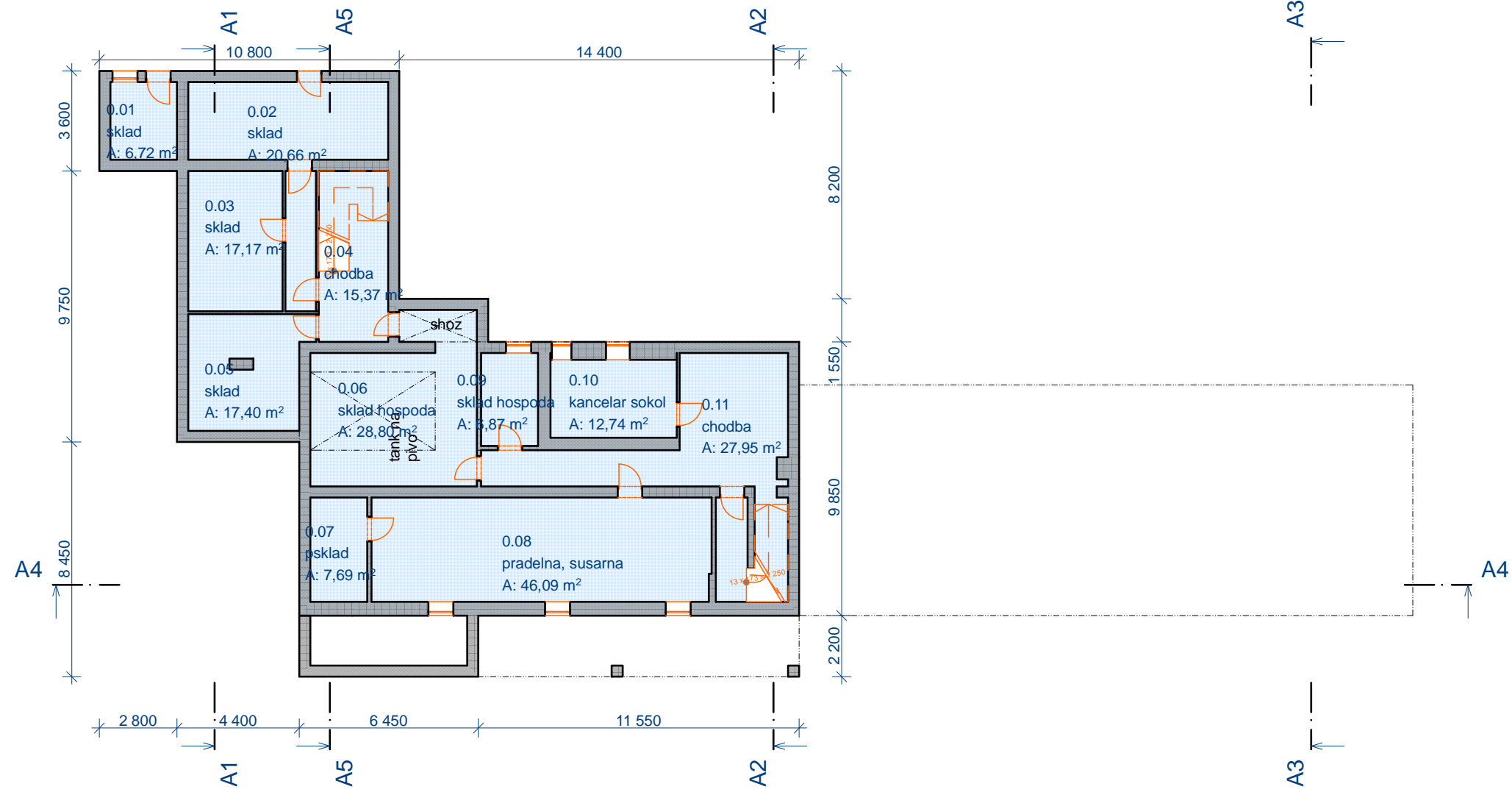
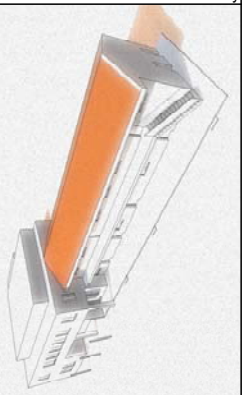

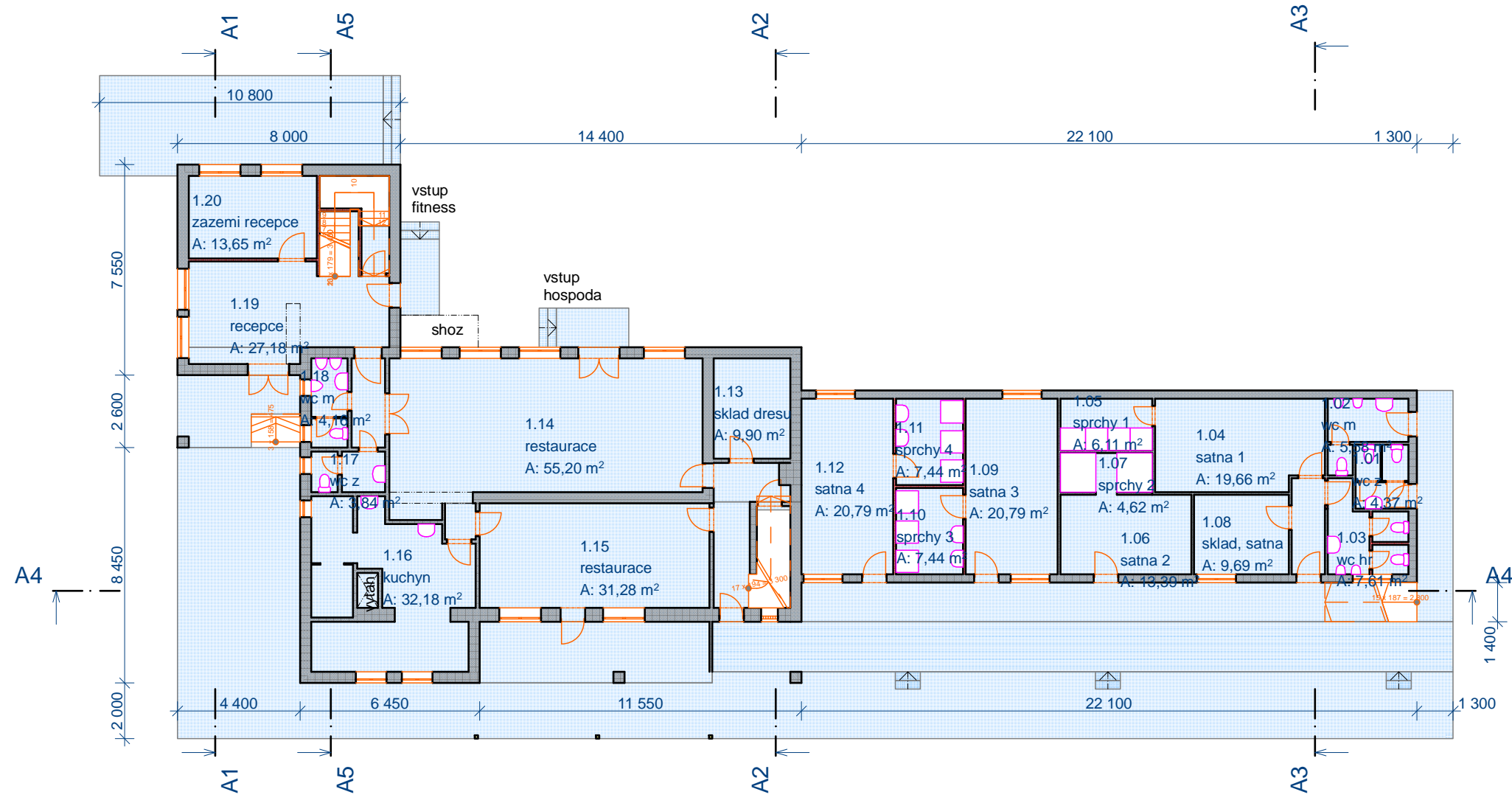

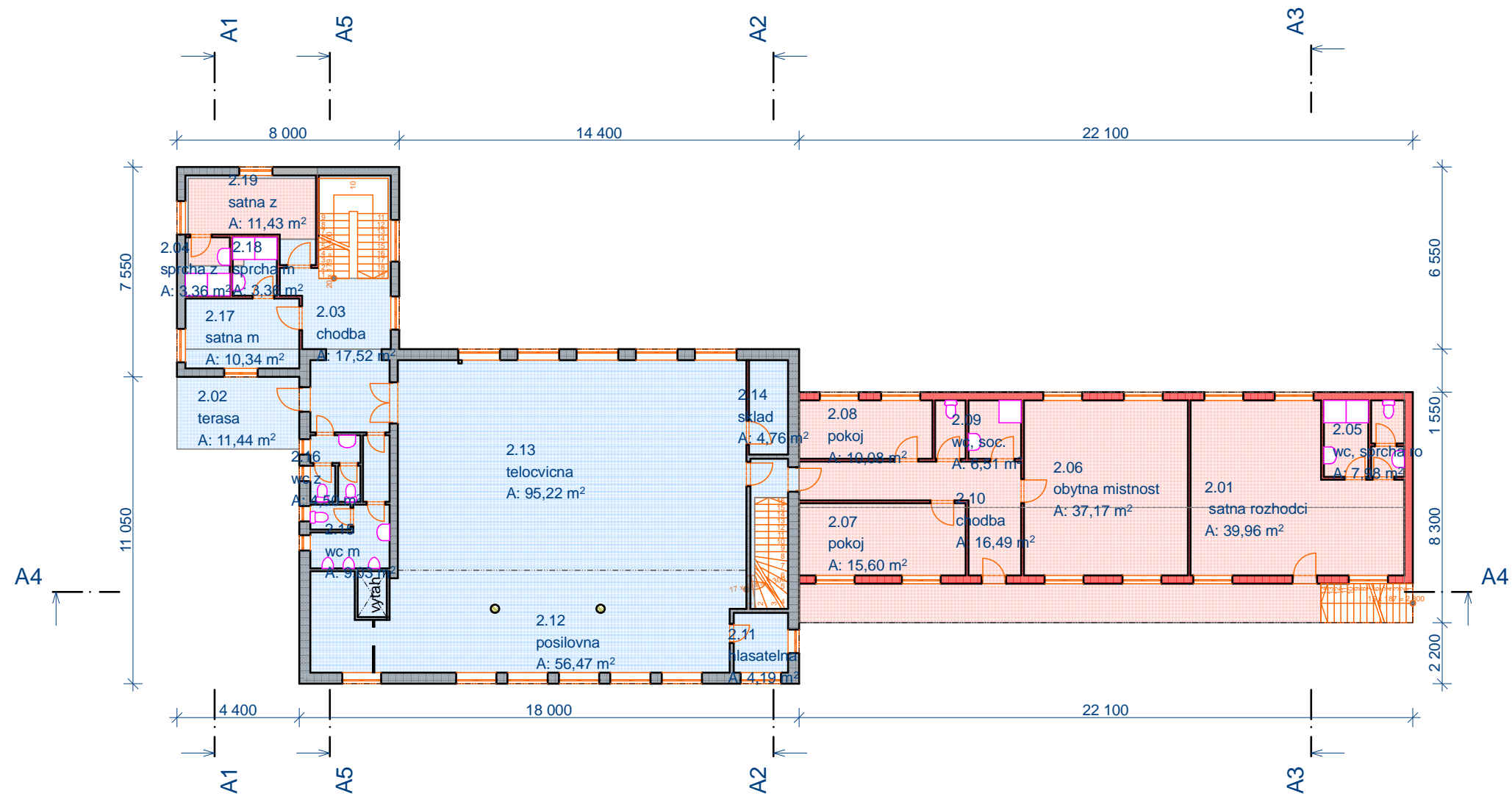
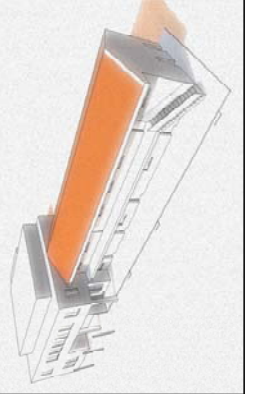

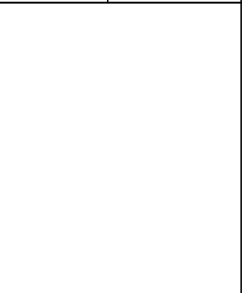
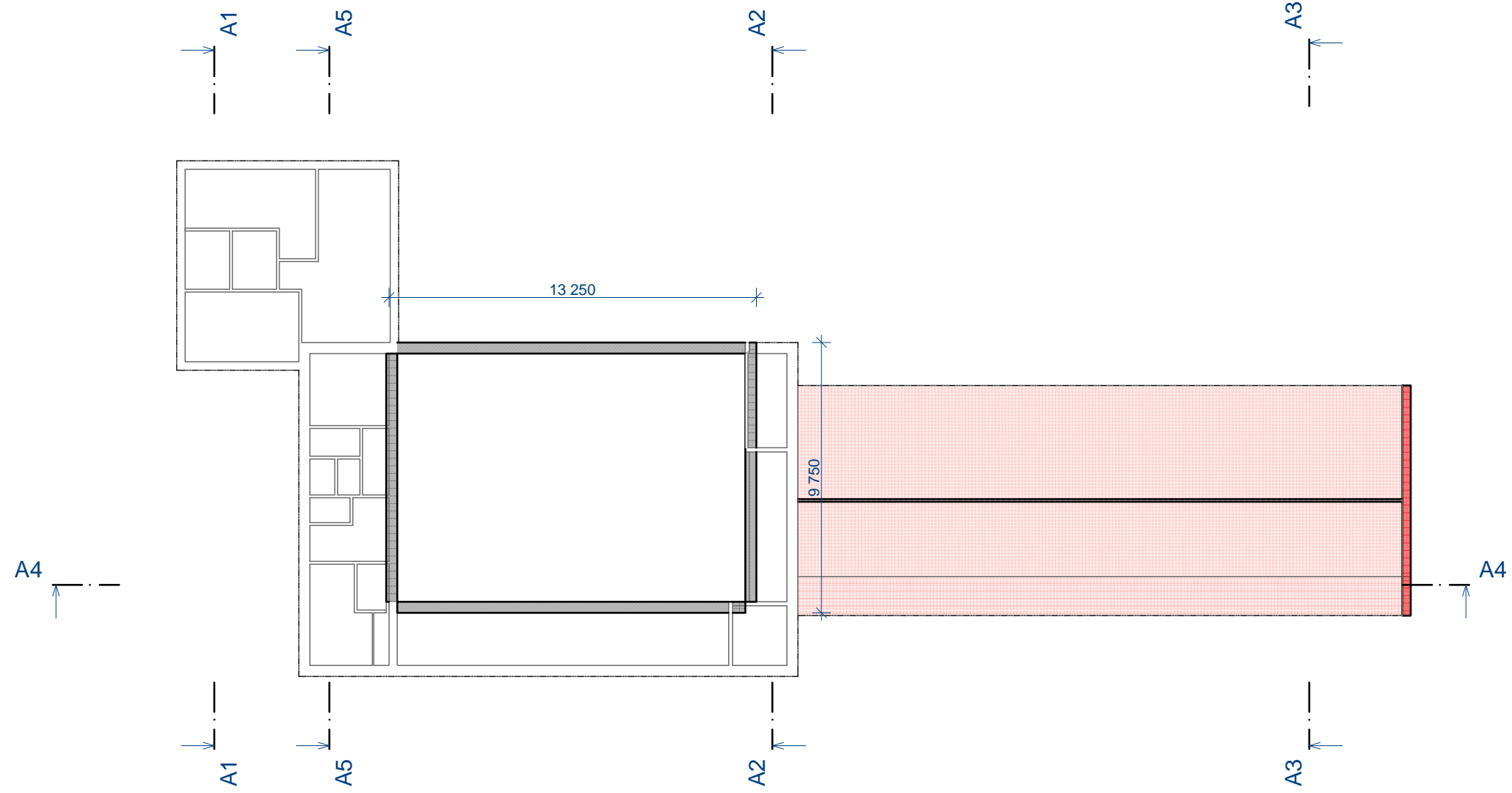
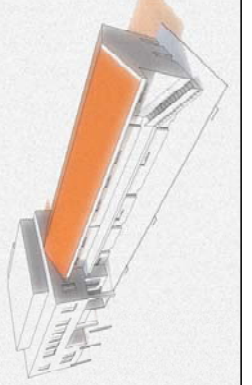



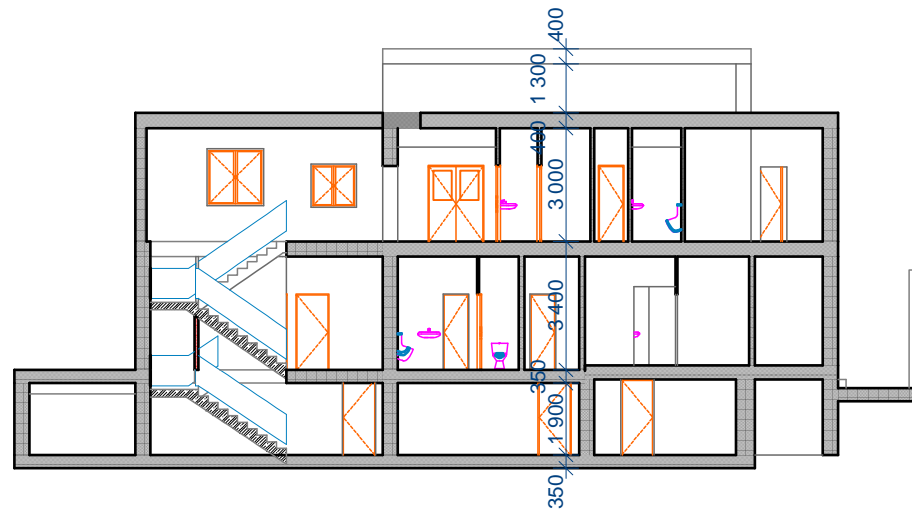
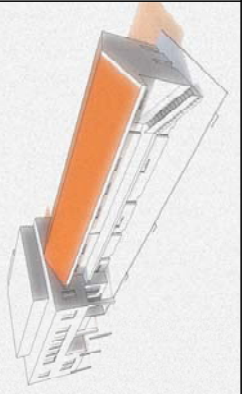

A5 Řez A-A' 1:200

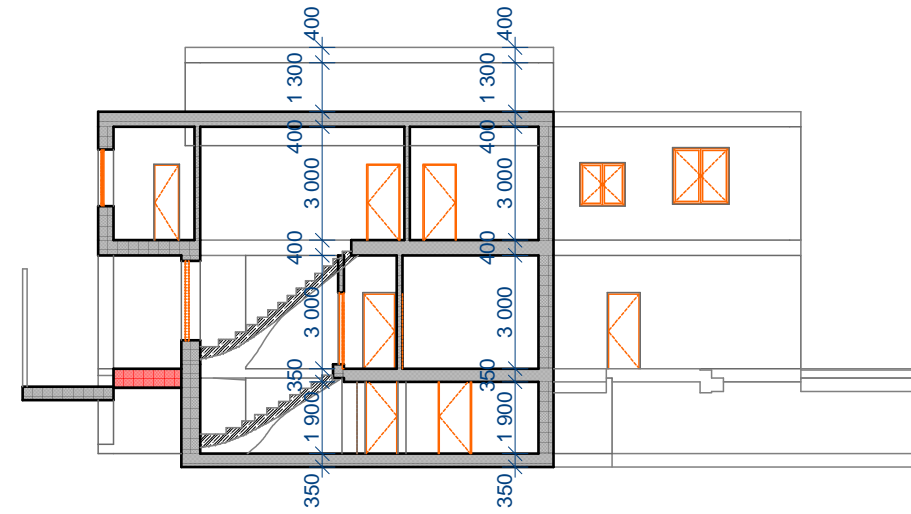

A2 Řez A-A' 1:200

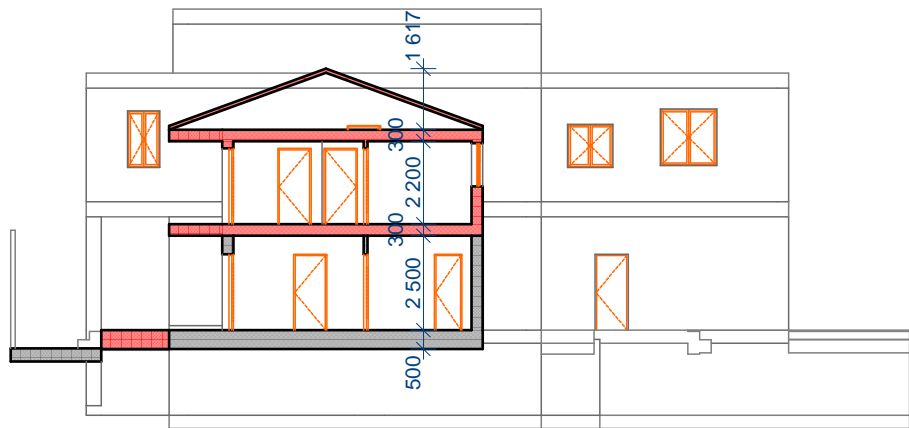

A3 Řez A-A' 1:200

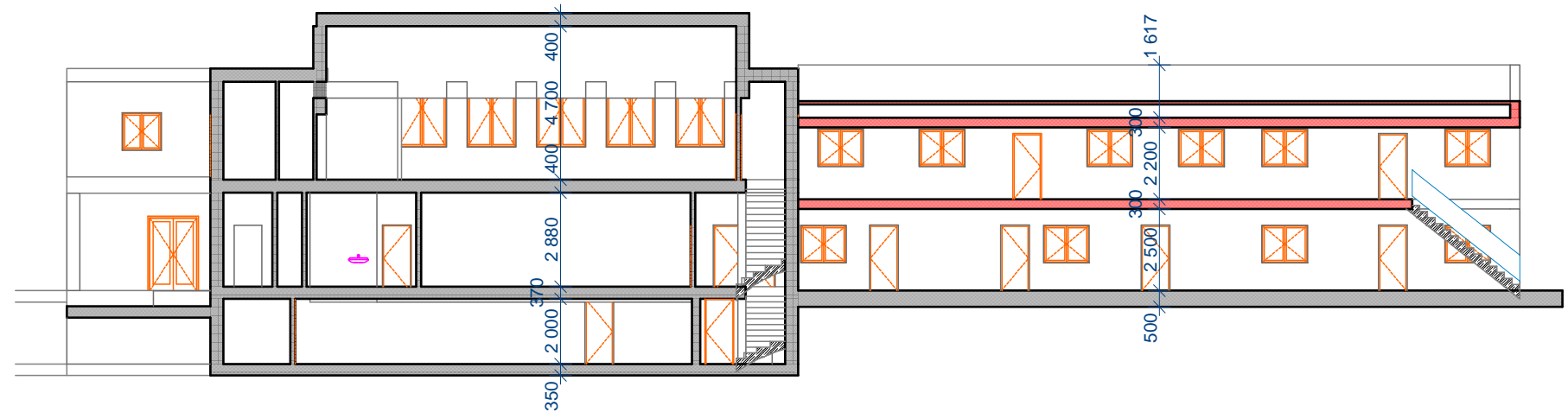

A4 Řez A-A' 1:200

